

Sirius WH 50-60-70

Wall Mounted Condensing Gas Boilers

Installation, Operation & Maintenance Manual



Working towards
a cleaner future

Dear Customer,

We are sure your new boiler will comply with all your requirements.

Do not dispose of this booklet as it contains the information, which will help you to run your boiler correctly and efficiently.

Do not leave any parts of the packaging (plastic bags, polystyrene, etc.) within children's reach as they are a potential source of danger.

POTTERTON COMMERCIAL boilers bear the CE mark in compliance with the basic requirements as laid down in the following Directives:

- Gas Directive 90/396/CEE
- Performance Directive 92/42/CEE
- Electromagnetic Compatibility Directive 89/336/CEE
- Low Voltage Directive 73/23/CEE



CONTENTS

INSTRUCTIONS PERTAINING TO THE USER

1. Instructions prior to installation	4
2. Instructions prior to commissioning	4
3. Commissioning of the boiler	5
4. Filling the boiler	12
5. Turning off the boiler	12
6. Prolonged standstill of the system. Frost protection	12
7. Servicing instructions	12

INSTRUCTIONS PERTAINING TO THE INSTALLER

8. General information	13
9. Instructions prior to installation	13
10. Boiler installation	14
11. Boiler size	15
12. Installation of flue and air ducts	15
13. Hydraulic system	19
14. Connecting the mains supply	23
15. Gas valve adjustment	30
16. Setting the boiler parameters	32
17. Control and operation devices	33
18. Positioning of the ignition and flame sensing electrode	34
19. Check of combustion parameters	34
20. Activating the chimney-sweep function	35
21. Annual service	35
22. Boiler schematic	36
23. Illustrated wiring diagram	37
24. Technical data	38

1. INSTRUCTIONS PRIOR TO INSTALLATION

This boiler is designed to heat water at a lower than boiling temperature at atmospheric pressure. The boiler must be connected to a central heating system and/or to a domestic hot water supply system in compliance with its performances and output power.

The boiler must be installed by a Qualified Service Engineer ensuring that the following operations are carried out:

- a) Careful checking that the boiler is fit for operation with the type of gas available. For more details see the notice on the packaging and the label on the appliance itself.
- b) Careful checking that the flue terminal draft is appropriate; that the terminal is not obstructed and that no other appliance exhaust gases are expelled through the same flue duct, unless the flue is especially designed to collect the exhaust gas coming from more than one appliance, in conformity with the standards and regulations in force.
- c) Careful checking that, in case the flue has been connected to pre-existing flue ducts, thorough cleaning has been carried out in that residual combustion products may come off during operation of the boiler and obstruct the flue duct.
- d) To ensure correct operation of the appliance and avoid invalidating the warranty, observe the following precautions:
 1. Hot water circuit:
If the water hardness is greater than 20 °F (1 °F = 10 mg calcium carbonate per litre of water) a polyphosphate or comparable treatment must be used in response to current regulations.

2. Heating circuit

2.1. New system

Before proceeding with installation of the boiler, the system must be cleaned and flushed out thoroughly to eliminate residual thread-cutting swarf, solder and solvents if any, using suitable proprietary products.

To avoid damaging metal, plastic and rubber parts, use only neutral cleaners, i.e. non-acid and non-alkaline. The recommended products for cleaning are:

SENTINEL X300 or X400 and FERNOX heating circuit restore. The use of this product must be strictly in accordance with the maker's directions. Finally the system must be dosed with a suitable inhibitor at 1% system volume.

2.2. Existing system

Before proceeding with installation of the boiler, the system must be cleaned and flushed out to remove sludge and contaminants, using suitable proprietary products as described in section 2.1.

To avoid damaging metal, plastic and rubber parts, use only neutral cleaners, i.e. non-acid and non-alkaline such as SENTINEL X100 and FERNOX heating circuit protective.

Remember that the presence of foreign matter in the heating system can adversely affect the operation of the boiler (e.g. overheating, noisy operation, or failure of the heat exchanger may occur).

Failure to observe the above will render the warranty null and void.

2. INSTRUCTIONS PRIOR TO COMMISSIONING

Initial lighting of the boiler must be carried out by a qualified service engineer. Ensure the following operations are carried out:

- a) Compliance of boiler parameters with (electricity, water, gas) supply systems settings.
- b) Compliance of installation with the standards and regulations in force.
- c) Appropriate connection to the power supply and earthing of the appliance.

Failure to observe the above will render the warranty null and void.

Prior to commissioning remove the protective plastic coating from the unit. Do not use any tools or abrasive detergents as you may damage the painted surfaces.

3. COMMISSIONING OF THE BOILER

To correctly light the burner proceed as follows:

- 1) Provide power supply to the boiler;
- 2) Open the gas cock;
- 3) Follow the directions given below regarding the adjustments to be made at the boiler control panel.

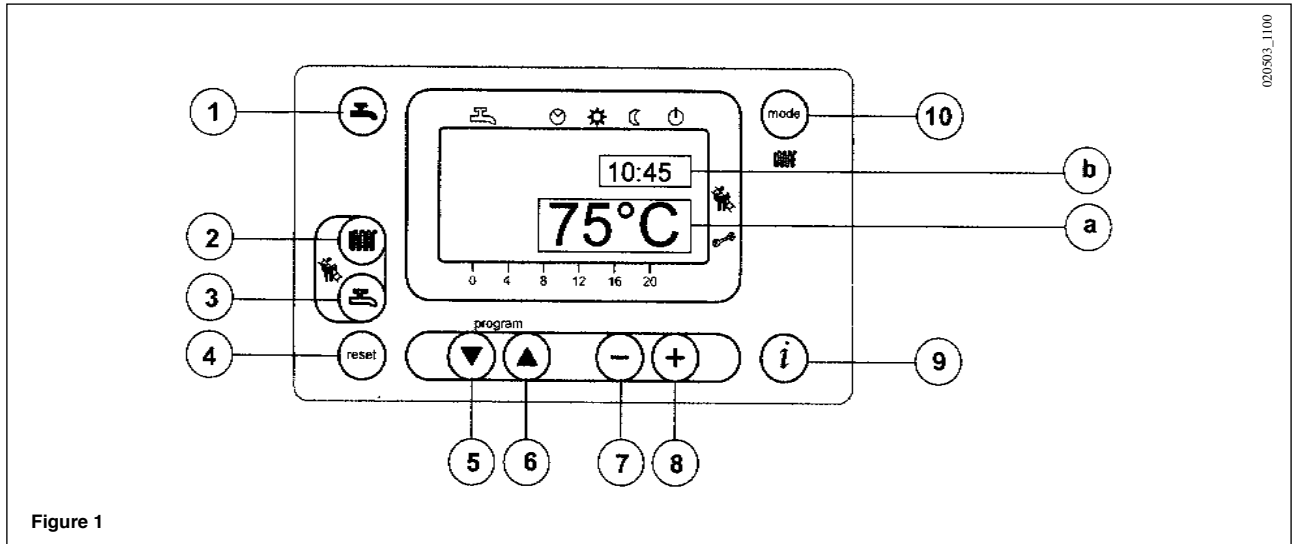

IMPORTANT: The instructions contained in this manual relating to the operation of the hot water circuit are relevant only if the appliance is actually connected to a hot water system.

KEYS

- Hot water on/off key
- Central heating water temperature setting key
- Hot water temperature setting key
- Reset key
- Program access and scroll keys
- Program access and scroll key
- Parameter setting key (decrease value)
- Parameter setting key (increase value)
- Data display reset key
- Central heating mode setting key

DISPLAY SYMBOLS

- Operation in hot water mode
 - Operation in central heating mode
 - Operation in automatic mode
 - Operation in manual mode at the maximum temperature set
 - Operation in manual mode at minimum temperature
 - Standby (off)
 - Outdoor temperature
 - Flame present (on)
 - Resettable alarm warning
- a) **MAIN display**
b) **SECONDARY display**

3.1 DESCRIPTION OF KEYS





 **(2)** This key can be pressed to set the central heating water output temperature as described in point 3-3.

 **(3)** This key can be pressed to set the hot water temperature as described in point 3-4.

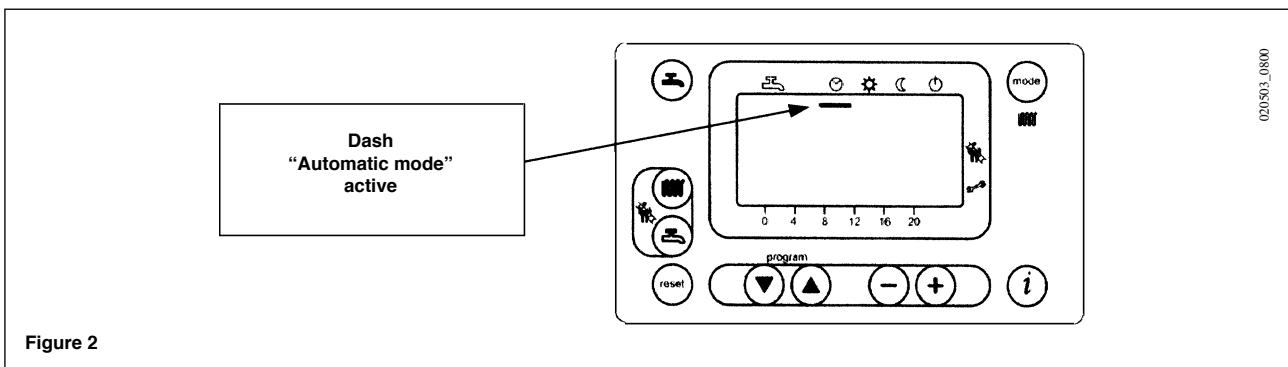
 **(10) Central heating mode operating key**



The  key can be pressed to activate four boiler central heating operating modes; these modes are identified by a black cursor line underneath the relative symbol on the display, and are as follows:







- a)  **Automatic operation.** Operation of the boiler is controlled by the timed program as described in point 3-5.1 “Daily timed program for operation of the central heating system”;
- b)  **Manual operation at the maximum temperature set.** The boiler comes into operation regardless of the timed program set. The operating temperature is that set using the  key (point 3-3: “Setting the maximum central heating temperature”);
- c)  **Manual operation at minimum temperature.** The operating temperature is that set in point 3-6: “setting the minimum central heating temperature”.



The manual transition from positions a) and b) to position c) involves shut-down of the burner and disconnection of the pump after the post-circulation delay interval (the factory setting for this parameter is 3 minutes).

d)  **standby.** The boiler does not work in central heating mode, although the frost protection function is still enabled.



 **(1) Hot water on/off key:** Press this key to activate or inhibit this function, which is identified by the appearance on the display of two black dashes under the  symbol.

 **(4) Reset key.** In case of a fault, referred to in point 3-7 “Faults and resetting the boiler”, the boiler can be restarted by pressing this key for at least two seconds. If this key is pressed with no fault present, the display will show the message “E153”, and the same key has to be pressed again (for at least two seconds) to restart the boiler.





 **(9) Data key.** This key can be pressed repeatedly to display the following information:
 - Temperature (°C) of the hot water ();
 - outdoor temperature (°C) (); only provided with the outdoor temperature sensor probe connected.

Press either of the   keys to return to the main menu.

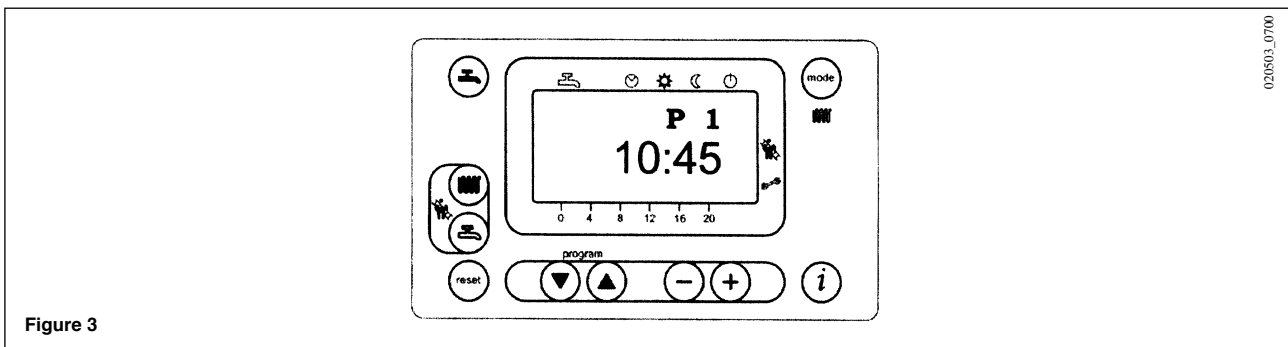



3.2 SETTING THE TIME



- a) Press either of the   keys to access the programming function; the display will show the letter P followed by a number (program line);







- b) Press the   keys until the display shows P1, referring to the time to be set;
- c) Press the   keys to set the time; on the display, the letter P will start to flash;
- d) Press the  key to save and exit the programming function;

3.3 SETTING THE MAXIMUM CENTRAL HEATING TEMPERATURE

- Press the  key (2-figure 1) to set the central heating water temperature;
- Press the   keys to set the temperature required;
- Press either of the   keys (1 or 10 - figure 1) to save and return to the main menu.







N.B – With the outdoor sensor connected, the  key (2 - figure 1) can be used to shift the central heating curve. Press the   keys to decrease or increase the room temperature in the premises to be heated.

3.4 SETTING THE MAXIMUM HOT WATER TEMPERATURE

- Press the  key (3-figure 1) to set the maximum hot water temperature;
- Press the   keys to set the temperature required;
- Press either of the   keys (1 or 10 - figure 1) to save and return to the main menu.

3.5 SETTING THE DAILY PROGRAM FOR OPERATION IN CENTRAL HEATING AND DOMESTIC HOT WATER MODES





3.5.1 Setting the daily times for central heating mode operation

- Press either of the   keys to access the programming function;
 - a) Press these keys until the display shows P11, referring to the program start time;
 - b) Press the   keys to set the time;
- Press the  key; the display will show P12, referring to the program end time;
- Repeat the operations described in points a and b until the third and last cycle is reached (program line P16);
- Press the  key to save and exit from the programming function.

3.5.2 Setting the daily times for domestic hot water mode operation

- As supplied by the factory the appliance is set up with the hot water function always enabled and the domestic hot water programming function disabled.
The instructions for enabling this program are given in chapter 17, which is addressed specifically to installers (parameter H91).
If the program is enabled program lines from 31 to 36 must be set up as described in heading 3-5.1.



3.6 SETTING THE MINIMUM CENTRAL HEATING TEMPERATURE

- Press either of the   keys to access the programming function;
- Press these keys until the display shows p5, referring to the temperature to be set;
- Press the   keys to set the temperature required.

This operating mode is enabled when minimum temperature central heating mode  is activated or when the daily central heating program does not require heat.

N.B – With the outdoor sensor connected, parameter P5 can be used to set the minimum room temperature in the premises to be heated (night setback).

3.7 TABLE FOR USER-SETTABLE PARAMETERS

Parameter N.	Parameter description	Factory setting	Range
P1	Time of day setting	— — — —	0...23:59
P5	Minimum central heating temperature setting (°C)	25	25..80
P11	Start of first daily period of automatic central heating	6:00	00:00...24:00
P12	End of first daily period of automatic central heating	22:00	00:00...24:00
P13	Start of second daily period of automatic central heating	0:00	00:00...24:00
P14	End of second daily period of automatic central heating	0:00	00:00...24:00
P15	Start of third daily period of automatic heating	0:00	00:00...24:00
P16	End of third daily period of automatic central heating	0:00	00:00...24:00
P31	Start of first daily period of hot water production (*)	0:00	00:00...24:00
P32	End of first daily period of hot water production (*)	24:00	00:00...24:00
P33	Start of second daily period of hot water production (*)	0:00	00:00...24:00
P34	End of second daily period of hot water production (*)	0:00	00:00...24:00
P35	Start of third daily period of hot water production (*)	0:00	00:00...24:00
P36	End of third daily period of hot water production (*)	0:00	00:00...24:00
P45	Reset of daily central heating and domestic hot water production programs (factory settings). Press the - + keys together for about 3 seconds; the number 1 appears on the display. Confirm by pressing either of the   keys	0	0...1

Note: Parameters from **P31** to **P36** can be displayed only if the domestic hot water program has been enabled as described in chapter 17 for the attention of the installer (parameter H91).

3.8 FAULT WARNINGS AND RESETTING THE BOILER

If a fault occurs, a flashing warning code appears on the display.

The fault warnings appear on the main display (figure 1 a) together with the  symbol (Figure 4).

To reset, press the reset  button for at least two seconds.

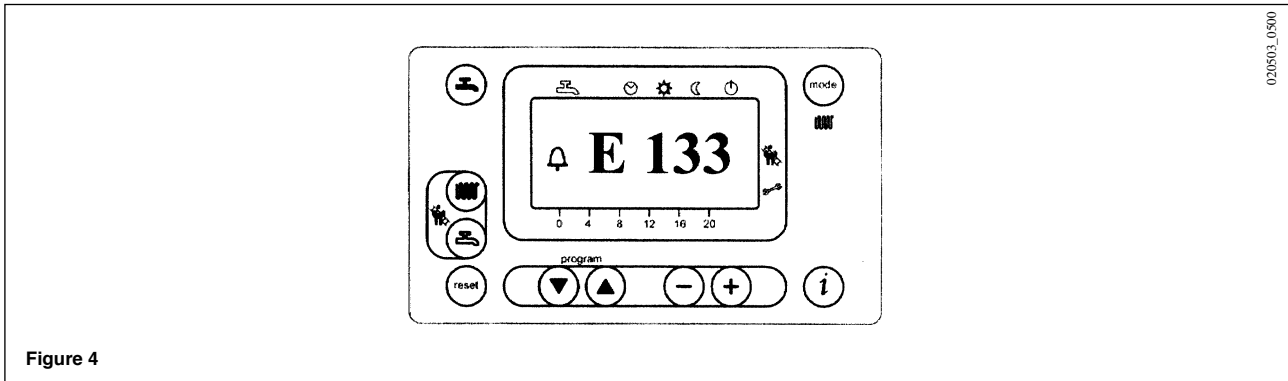

Figure 4

Fault warnings appear on the secondary display (figure 1 b) alternating with the time, both of them flashing (figure 4.1). It is not possible to reset malfunction warnings which appear on the secondary display as the cause of the alarm has first to be removed.

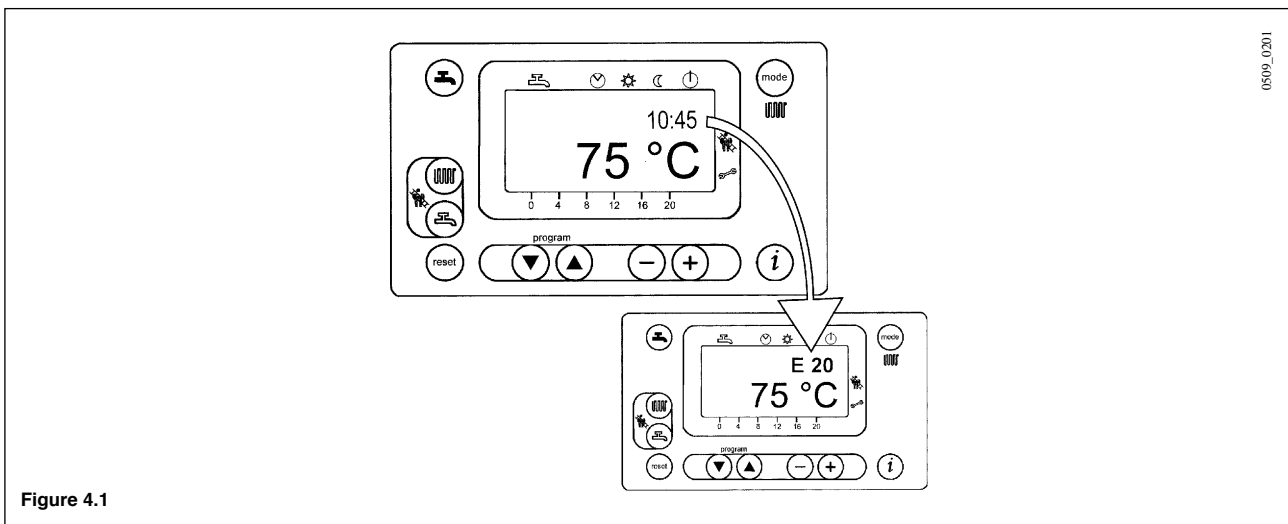

Figure 4.1

3.9 FAULT WARNINGS TABLE

Fault code	Fault description	Action required
E10	Outdoor temperature sensor failure	Call the authorised service centre to check the wiring and/or replace the sensor.
E20	NTC output sensor failure	Call the authorised service centre to replace the sensor.
E50	Hot water NTC sensor failure	Call the authorised service centre to replace the sensor.
E110	Safety or flue gas thermostat tripped	Press the reset key (for about 2 seconds: if this device is triggered repeatedly, call the authorised service centre)
E128	Loss of flame during operation (the ionization current has fallen below the limit)	Call the authorised service centre to check the flame.
E129	Minimum fan speed limit is not met	Call the authorised service centre.
E132	lack of gas pressure / external thermostat	Call the gas supplier. Call the authorised service centre.
E133	No gas	Press the reset key (for about 2 seconds); if the fault persists, call the authorised service centre)
E151	Boiler circuit board error	Press the reset button if the display presents the (🔔) symbol, otherwise switch off the boiler at the mains and switch it on again after 10 seconds. If the fault persists, call an authorised service centre. Check the position of the ignition electrodes (section 18).
E153	The reset key has been pressed inappropriately	Press the key again (about 2 seconds)
E154	Internal error on boiler circuit module	Press and hold reset button (2 seconds approx.) then press again when warning E153 appears
E160	Fan speed threshold not reached	Call the authorised service centre to check the fan.
E164	No hydraulic differential pressure switch enabling signal	Check that the system is at the rated pressure. (Refer to the section on filling the system). If the fault persists, call the authorised service centre.

All the faults are displayed in order of importance; if several faults occur simultaneously, the first to be displayed is the one with highest priority. After the cause of the first fault has been removed, the second one will be displayed, and so on.

If any given fault occurs frequently, contact the authorised Service Centre.

4. FILLING THE BOILER

Important: Regularly check that the pressure displayed by the pressure gauge is between 1 to 4 bar, with the boiler not operating.

In case the pressure is lower open the boiler filling tap.

We recommend you open the tap very slowly in order to let off the air.

In case pressure drops occur frequently have the boiler checked by a Qualified Service Engineer.

5. TURNING OFF THE BOILER

To shut down the boiler switch off the electrical supply to the appliance.

6. PROLONGED STANDSTILL OF THE SYSTEM. FROST PROTECTION

We recommend you avoid draining the whole system as raw water makeup will lead to harmful limestone deposits inside the boiler and on the heating elements.

In case the boiler is not operated during wintertime and is therefore exposed to danger of frost we suggest you add some specific-purpose anti-freeze to the water contained in the system (e.g.: propylene glycole coupled with corrosion and scaling inhibitors).

The electronic management of the boilers includes a 'frost protection' function which operates the burner to reach a heating flow temperature of 30° C when the system heating flow temperature drops below 5°C.

The frost protection function is enabled if:

- * electrical supply to the boiler is on;
- * the gas service cock is open;
- * the system pressure is as required;
- * the boiler is not isolated.

7. SERVICING INSTRUCTIONS AND GAS CHANGE

To maintain efficient and safe operation of your boiler have it checked by a Qualified Service Engineer at the end of every heating season. Careful servicing will ensure economical operation of the system.

Do not clean the outer casing of the appliance with abrasive, aggressive and/or easily flammable cleaners (i.e.: gasoline, alcohol, and so on). Always isolate the electrical supply to the appliance before cleaning it (see section 5 Turning off the boiler).

These boilers are produced for natural gas and can be converted to work with LPG (G 31). Any gas change must be effected by a Qualified Service Engineer.

8. GENERAL INFORMATION

The following remarks and instructions are addressed to Service Engineers to help them carry out a faultless installation. Instructions regarding lighting and operation of the boiler are contained in the 'Instructions pertaining to the user' section.

Note that installation, maintenance and operation of the gas appliances must be performed exclusively by qualified personnel in compliance with current standards.

Please note the following:

- * This boiler can be connected to any type of double- or single feeding pipe convector plates, radiators, thermoconvectors. Design the system sections as usual though taking into account the available output / pump head performances.
- * Do not leave any packaging components (plastic bags, polystyrene, etc.) within children's reach as they are a potential source of danger.
- * Initial lighting of the boiler must be effected by a Qualified Service Engineer.

Failure to observe the above will render the warranty null and void.

9. INSTRUCTIONS PRIOR TO INSTALLATION

This boiler is designed to heat water at a lower than boiling temperature at atmospheric pressure. The boiler must be connected to a central heating system and, on models with this option, to a domestic hot water supply system in compliance with its performances and output criteria.

IMPORTANT! The gas boiler is supplied **without** the following components which must be provided exclusively by qualified personnel:

- **Expansion vessel;**
- **Pressure relief valve;**
- **Circulating pump;**
- **Boiler filling tap.**

Before connecting the boiler ensure the following operations have been completed:

- a) Check that the boiler is fit for operation with the type of gas available. For more details see the notice on the packaging and the label on the appliance itself.
- b) Check that the flue terminal draft is appropriate; that the terminal is not obstructed and that no other appliance exhaust gases are expelled through the same flue duct, unless the flue is especially designed to collect the exhaust gas coming from more than one appliance, in conformity with the standards and regulations in force.
- c) Check that, in case the flue has been connected to pre-existing flue ducts, thorough cleaning has been carried out in that residual combustion products may be created during operation of the boiler and obstruct the flue duct.

To ensure correct operation of the appliance and avoid invalidating the warranty, observe the following precautions:

1. Hot water circuit:

If the water hardness is greater than 20 °F (1 °F = 10 mg calcium carbonate per litre of water) a polyphosphate or comparable treatment system responding to current regulations must be used.

2. Heating circuit

2.1. New system

Before proceeding with installation of the boiler, the system must be cleaned and flushed out thoroughly to eliminate residual thread-cutting swarf, solder and solvents if any, using suitable proprietary

products.

To avoid damaging metal, plastic and rubber parts, use only neutral cleaners, i.e. non-acid and non alkaline. The recommended products for cleaning are:

SENTINEL X300 or X400 and FERNOX heating circuit restore. Please ensure to use this product proceeding strictly in accordance with the manufacturers instructions. Finally fill the system with the correct strength of central heating inhibitor.

2.2. Existing system

Before proceeding with installation of the boiler, the system must be cleaned and flushed out to remove sludge and contaminants, using suitable proprietary products as described in section 2.1.

To avoid damaging metal, plastic and rubber parts, use only neutral cleaners, i.e. non-acid and non-alkaline such us SENTINEL X100 and FERNOX heating circuit protective. To use this product proceeding strictly in accordance with the maker's directions.

Remember that the presence of foreign matter in the heating system can adversely affect the operation of the boiler (e.g. overheating and noisy operation of the heat exchanger). Dose with inhibitor.

Failure to observe the above will render the guarantee null and void.

10. BOILER INSTALLATION

Decide upon the boiler location, then tape the template on the wall.

Connect the pipework to the gas and water inlets prearranged on the template lower bar.

If you are either installing the boiler on a pre-existing system or replacing it, we suggest you also fit strainers on the system return pipework to the boiler to collect the deposits and scaling which may remain and be circulated in the system after the initial filling.

When the boiler is fixed on the template connect the flue and air ducts (fittings supplied by the manufacturer) according to the instructions given in the following relevant sections.

Connect the condensate outlet to the siphon supplied with the boiler. Connect the siphon to a drain, making sure there is a continuous slope. Horizontal sections must be avoided.

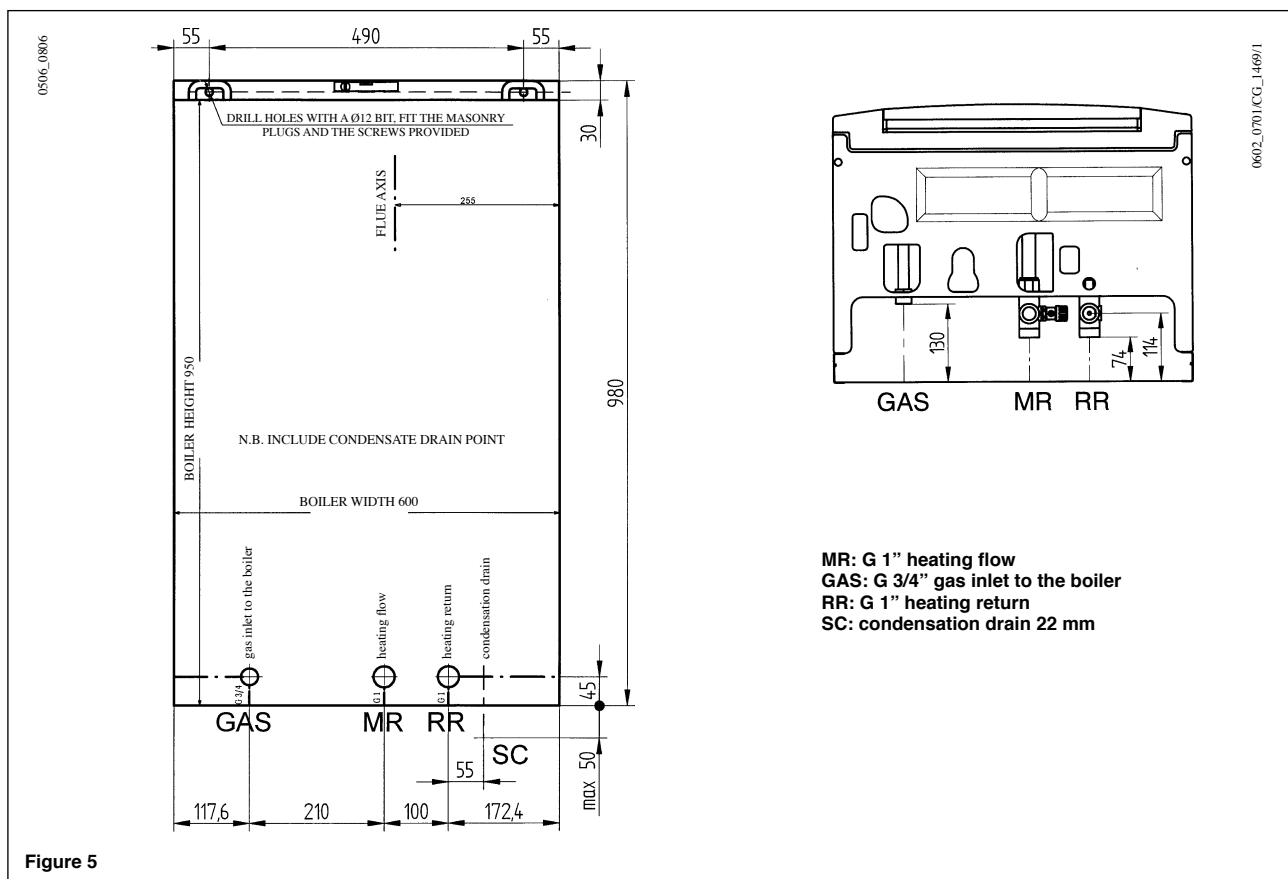

11. BOILER SIZE

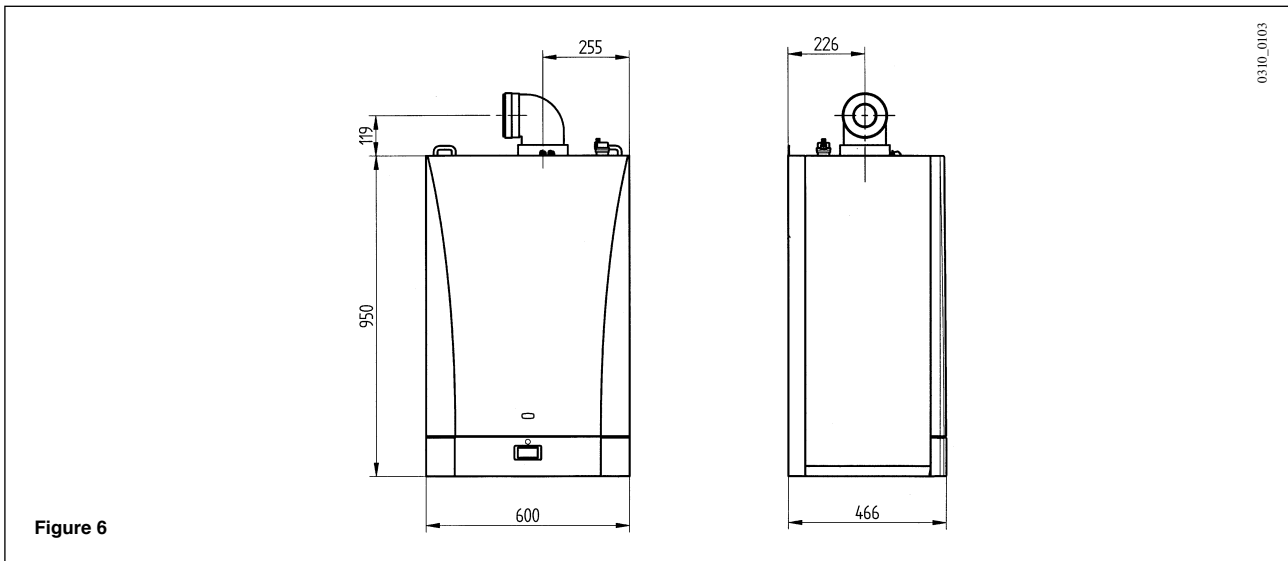

12. INSTALLATION OF FLUE AND AIR DUCTS

We guarantee ease and flexibility of installation for the boiler thanks to the fittings and fixtures supplied (described below).

The boiler is especially designed for connection to an exhaust flue / air ducting, with either concentric, vertical or horizontal terminal.

Where exhaust and intake flues not supplied by POTTERTON COMMERCIAL have been installed, these must be certified for the type of use and must have a maximum pressure drop of 100 Pa for the complete flue installation.

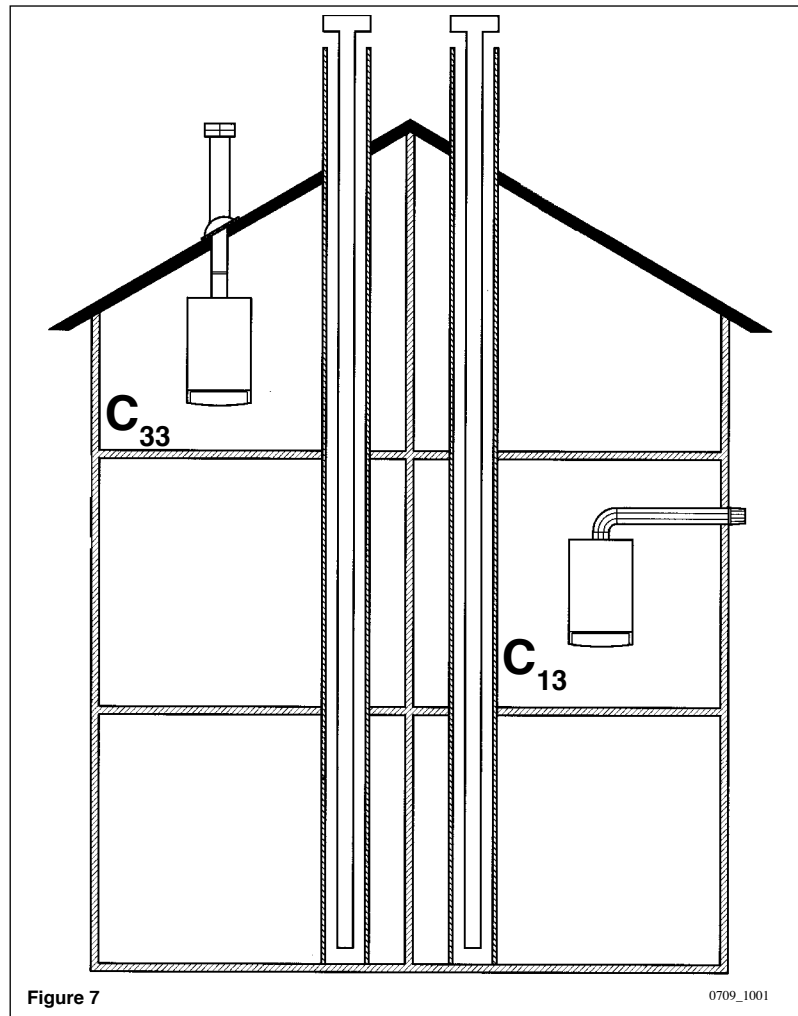

HORIZONTAL CONCENTRIC FLUES					
Boiler	Flue Size	Number of Bends 90°			
		1	2	3	4
WH50	Ø80/125	9 m	8 m	7 m	6 m
WH60	Ø80/125	9 m	8 m	7 m	6 m
WH70	Ø80/125	9 m	8 m	7 m	6 m

VERTICAL CONCENTRIC FLUES					
Boiler	Flue Size	Number of Bends 90°			
		1	2	3	4
WH50	Ø80/125	9 m	8 m	7 m	6 m
WH60	Ø80/125	9 m	8 m	7 m	6 m
WH70	Ø80/125	9 m	8 m	7 m	6 m

CONVENTIONAL FLUE					
Boiler	Flue Size	Number of Bends 90°			
		1	2	3	4
WH50	Ø80	59,5 m	59 m	58,5 m	58 m
WH60	Ø80	59,5 m	59 m	58,5 m	58 m
WH70	Ø80	59,5 m	59 m	58,5 m	58 m

Concentric flue

This type of duct allows to emit exhaust gases and to draw combustion air from outside the building. The 87° coaxial bend allows to connect the boiler to a flue-air duct in any direction as it can rotate through 360°.

If the flue outlet is placed outside, the flue-air ducting must protrude at least 18mm out of the wall to allow aluminium weathering tile to be fitted and sealed to avoid water leakages. If the terminal is below 2m then a terminal guard is required.

Ensure a minimum downward slope of 3° towards the boiler.

A 87° bend reduces the total flue length by 1 metre.

A 45° bend reduces the total flue length by 0.5 metre.

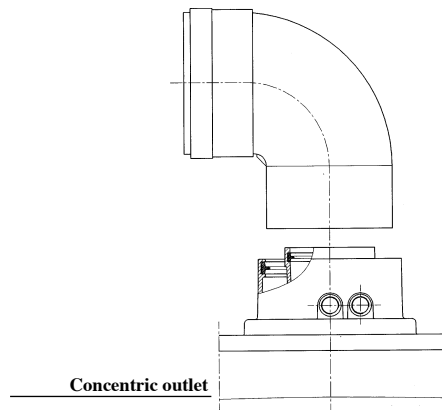
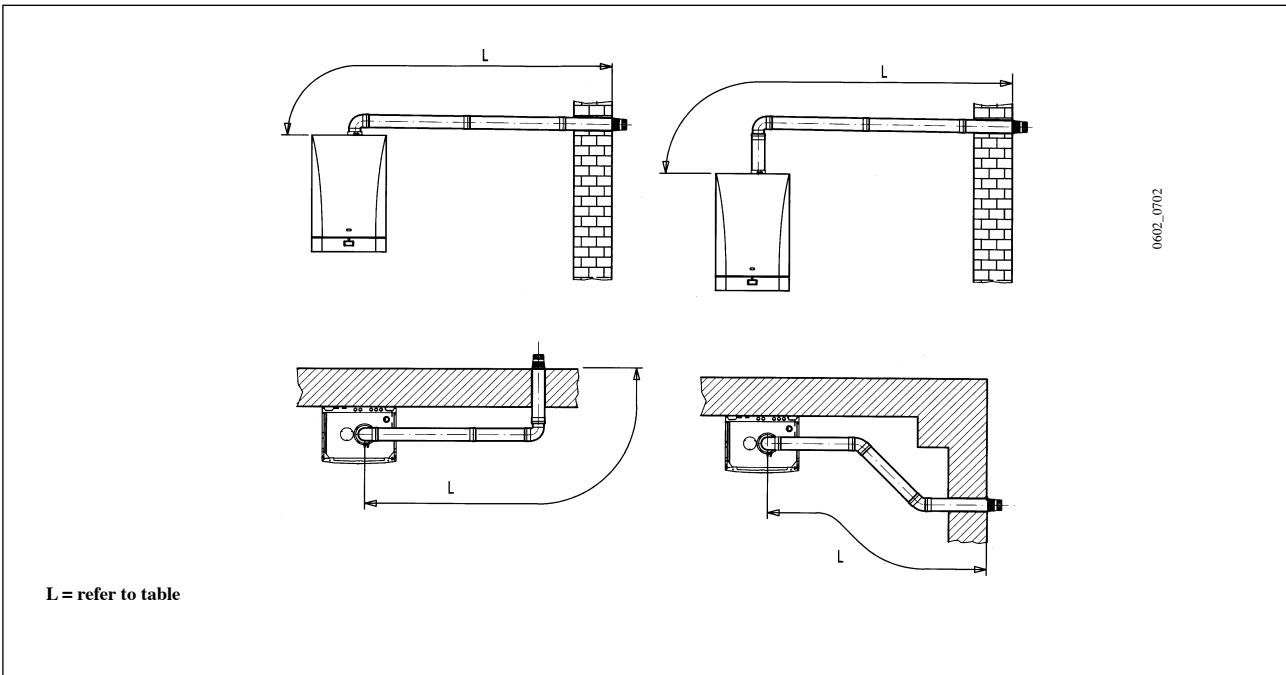

Figure 8

12.1 HORIZONTAL FLUE TERMINAL Ø 80/125 INSTALLATION OPTIONS



L = refer to table

0602_0702

12.2 VERTICAL FLUE TERMINAL Ø 80/125 mm INSTALLATION OPTIONS

This type of installation can be carried out both on a flat or pitched roof by fitting a terminal, an appropriate weathering tile and sleeve, (supplementary fittings supplied as options).

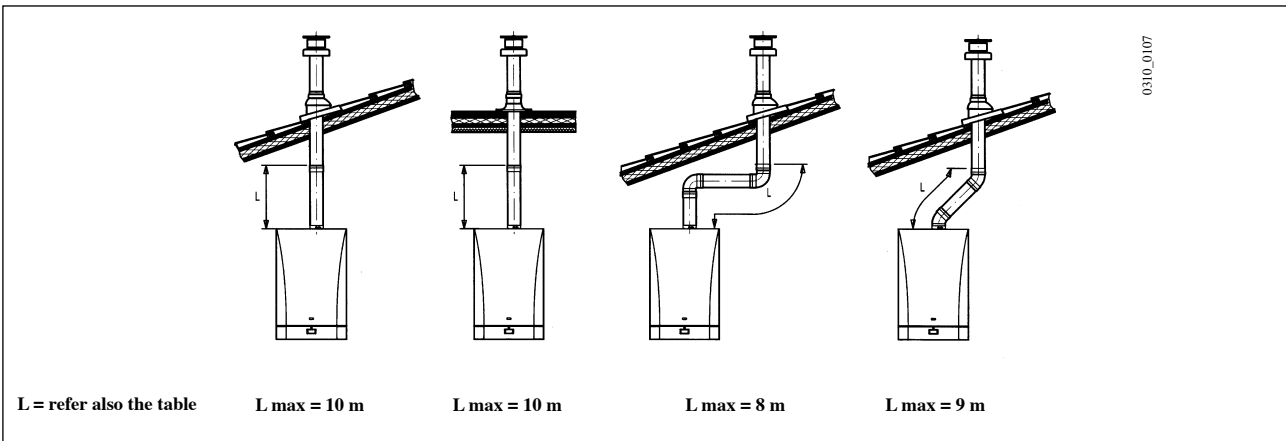

L = refer also the table

L max = 10 m

L max = 10 m

L max = 8 m

L max = 9 m

0310_0107

12.5 FAN RPM UPDATING DEPENDING ON FLUE LENGTH (e.g. figure 7)

To ensure the correct rated heat output to the maximum and minimum heat input, it is necessary to update the speed (rpm) of the fan, it depends on the length of the flue (par. 12), in accordance with the installation of flue and air pipes as indicated in the tables below. The factory-set value is referred to the minimum length of flue pipe (0÷4 m for concentric, 0÷20 m for twin). To carry such updating, changing the speed of the fan (rpm) at the maximum and minimum heat input, refer to par. 16.

WH 50

CONCENTRIC PIPE Ø 80/125 (C13-C33-C43)		
Pipes length (m)	Parametres H536-H613	Parametres H612
	Max heat output (rpm)	Min heat output (rpm)
(*) 0 - 4	5500	1900
5 - 10	5900	2100

(*) Default setting parameters

WH 60

CONCENTRIC PIPE Ø 80/125 (C13-C33-C43)		
Pipes length (m)	Parametres H536-H613	Parametres H612
	Max heat output (rpm)	Min heat output (rpm)
(*) 0 - 4	5600	1650
5 - 10	6000	1800

(*) Default setting parameters

WH 70

CONCENTRIC PIPE Ø 80/125 (C13-C33-C43)		
Pipes length (m)	Parametres H536-H613	Parametres H612
	Max heat output (rpm)	Min heat output (rpm)
(*) 0 - 4	6000	1850
5 - 10	6500	2100

(*) Default setting parameters

13. HYDRAULIC DIAGRAM

Applications and Installation Details

13.1 HYDRAULIC SYSTEM 1

(Pumped heating circuits with remote control QAA73 or Room Thermostat, including hot-water tank, without and with primary loop)

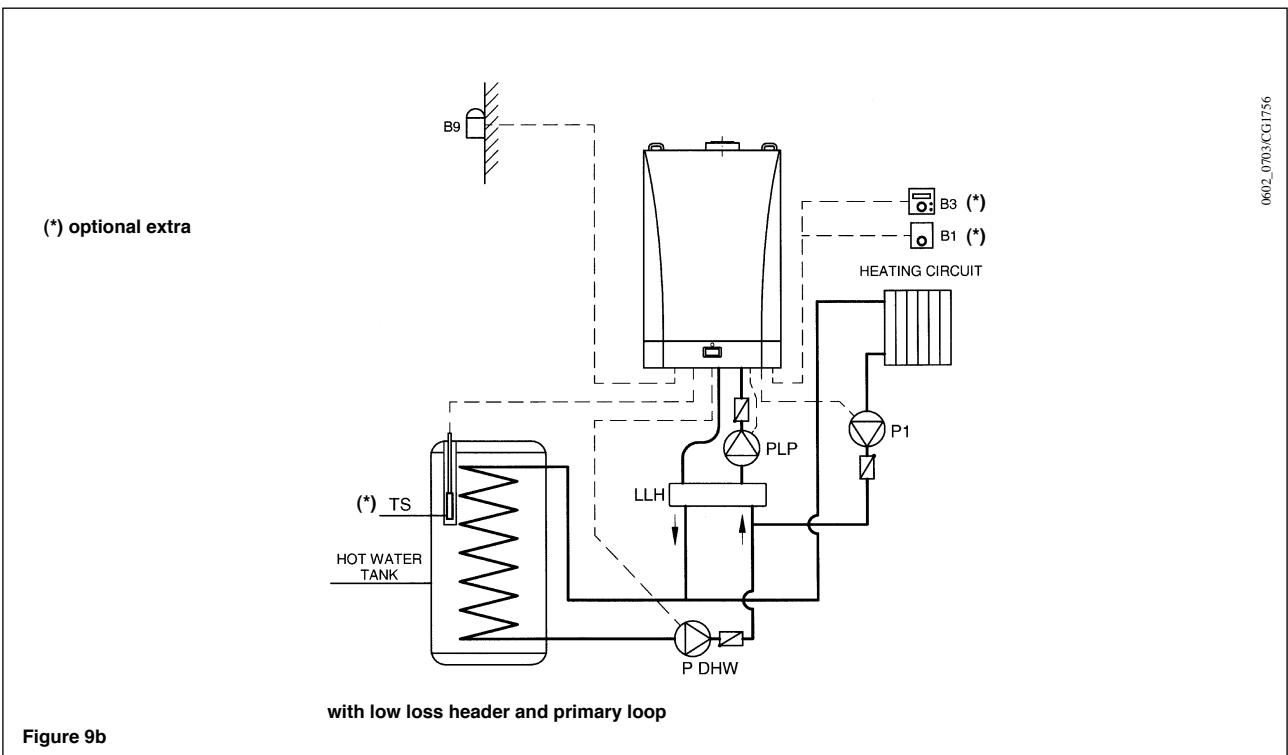
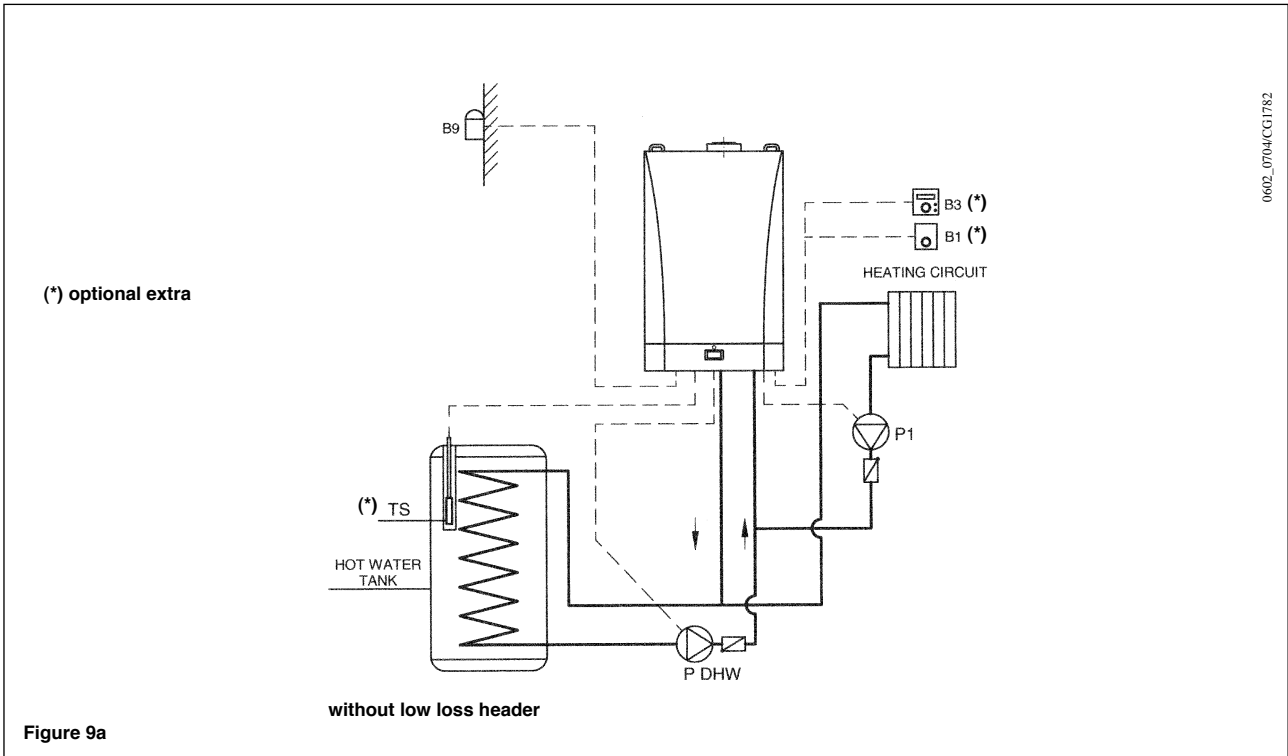

- TS: Tank Sensor (QAZ36)*
- B3: Room Control Module (QAA73)*
- B1: Room Thermostat
- B9: Outdoor Temperature Sensor (QAC34) (supplied with the gas boiler)
- P1: Heating Pump
- PDHW: Hot Water pump
- PLP: Primary Pump (only for figure 9b)

(* Available Optional Extra

- Pumps (Not Supplied)
- Isolating Valve (Not Supplied)
- Installer Wiring -----
- Hot Water Cylinder (Not Supplied)
- Low Loss Header (Not Supplied)
- Non return valve (Not supplied)

Applications (pumps, sensor, remote control ...) have to be connected to terminal as follows (see also section 14):

	WITH QAA73 REMOTE CONTROL	WITH ROOM THERMOSTAT
APPLICATION		
	TERMINAL BOARD	TERMINAL BOARD
PRIMARY PUMP PLP (only for figure 9b)	M1: A – B	M1: A – B
DHW PUMP PDHW	M3: 13 – 14	M3: 13 – 14
HEATING PUMP P1	M3: 11 – 12	M3: 11 – 12
DHW SENSOR TS	M2: 7 – 8	M2: 7 – 8
REMOTE CONTROL QAA73	M2: 1 – 2	NO
ROOM THERMOSTAT	M2: 3 – 4 OPEN	M2: 3 – 4

Parameter changes requires (see also section 16):

PCB PARAMETER	Description	Setting Parameter
H552	Hydraulic system	H552 = 2
H553	KonfigHKS	H553 = 21
H615	KonfigAusgang	H615 = 9
H632	Wanfo Q8	H632 = 00001100

13.2 HYDRAULIC SYSTEM 2

(Pumped heating circuits with Room Thermostat and compensated circuit with remote control QAA73, including hot-water tank, with primary loop)

- TS: Tank Sensor (QAZ36)*
- B3: Room Control Module (QAA73)*
- B1: Room Thermostat
- B9: Temperature Sensor (QAC34) (supplied with the gas boiler)
- Zone Controller (Clip-in AGU2.500)*
- FS: Flow Sensor (QAD36: supplied with AGU2.500)*
- P1: Heating Pump
- P DHW: Hot Water pump
- PLP: Primary Pump
- 3WV: 3-way Valve (power open / power close)

(*) Available Optional Extra

- Pumps (Not Supplied)
- Isolating Valve (Not Supplied)
- Installer Wiring -----
- Hot Water Cylinder (Not Supplied)
- Low Loss Header (Not Supplied)
- Non Return Valve (Not supplied)

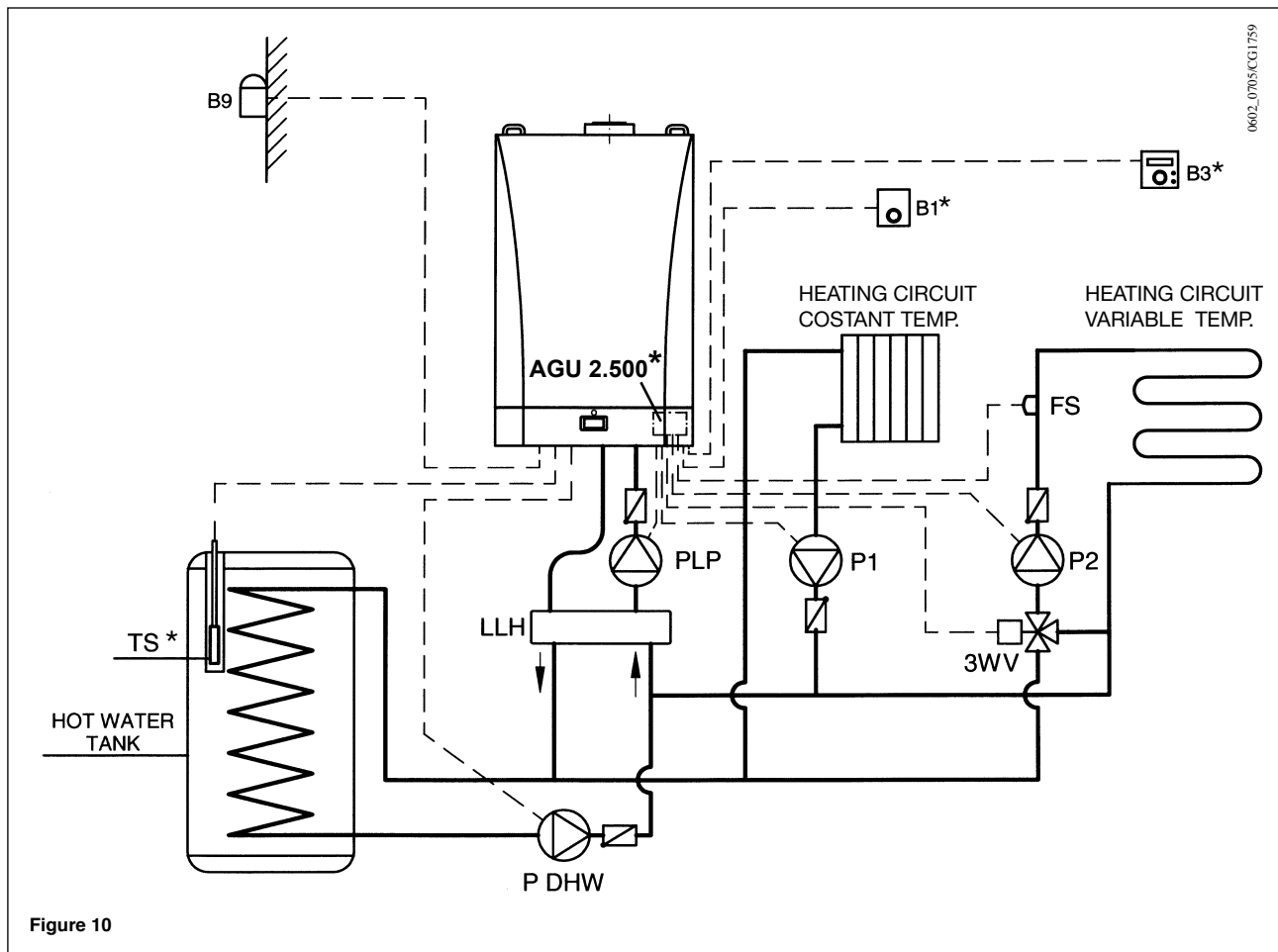

Figure 10

Applications (pumps, sensor, remote control ...) have to be connected to terminal as follows (see also section 14):

APPLICATION	TERMINAL BOARD
PRIMARY PUMP PLP	M1: A – B
DHW PUMP PDHW	M3: 13 – 14
HEATING PUMP P1	M3: 11 – 12
DHW SENSOR TS	M2: 7 – 8
REMOTE CONTROL QAA73 (LOW TEMPERATURE)	M2: 1 – 2
ROOM THERMOSTAT	M2: 3 – 4
HEATING PUMP P2	CLIP IN AGU 2.500
3 WAY VALVE	CLIP IN AGU 2.500
FLOW SENSOR	CLIP IN AGU 2.500

Parameter changes requires (see also section 16):

PCB PARAMETER	Description	Setting Parameter
H552	Hydraulic system	H552 = 50
H553	KonfigHKS	H553 = 12
H615	KonfigAusgang	H615 = 9
H632	Wanfo Q8	H632 = 00001111

13.3 HEAT EXCHANGER PRESSURE DROP

Boiler	Hydraulic Resistance and Water Flow Rates							
	11°C ΔT		15°C ΔT		20°C ΔT		30°C ΔT	
	kPa	Lit/sec	kPa	Lit/sec	kPa	Lit/sec	kPa	Lit/sec
WH50	70,61	0,98	31,38	0,72	11,77	0,54	10,79	0,36
WH60	61,78	1,19	30,40	0,88	17,65	0,66	12,26	0,44
WH70	56,88	1,41	34,32	1,04	20,59	0,78	11,77	0,52

Boiler	Minimum Water Flow Rates	
	Lit/sec	
WH50	0,28	
WH60	0,28	
WH70	0,35	

14. CONNECTING THE MAINS SUPPLY

Electrical safety of the appliance is only guaranteed by correct earthing, in compliance with the applicable standards and regulations.

Connect the boiler to a 230V earthed power supply by means of the three-pin cable supplied ensure that the polarity is correct.

Use a double-pole switch isolator with a contact separation of at least 3mm in both poles.

In case you replace the power supply cable fit a HAR H05 VV-F' 3x0.75mm² cable with an 8mm diameter maximum outer sheath.

The fuse, a fast-acting type rated 2A, is incorporated into the power supply terminals (remove the black fuse holder to enable inspection and/or replacement).

IMPORTANT: Check that the overall current drawn by accessories connected to the appliance is less than 1 amp. If the value is greater, a relay must be wired between the boiler control circuit board and the accessories drawing the higher current.

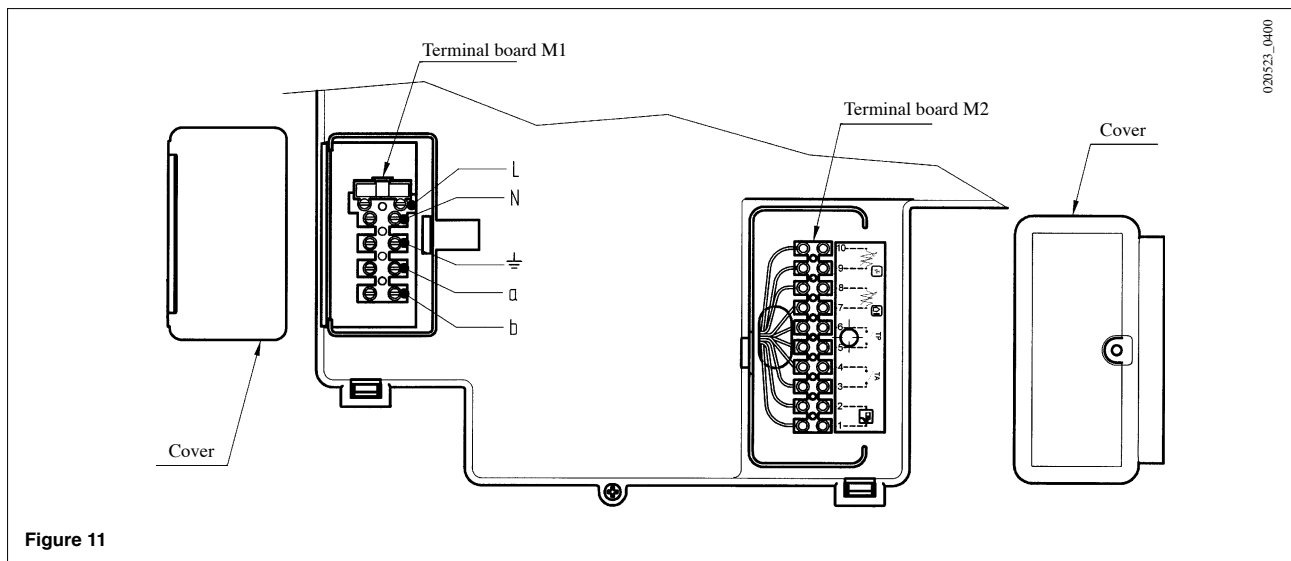

14.1 CONNECTING THE PUMPS

Turn the control box downward to access terminal boards M1 and M3 used for the electrical connections by removing the protective covers (see figure 12).

Terminals M1 a – b: connection of the primary loop pump for the heating system (PLP)

Check the correct size and rating of the pump by referring to its hydraulic resistance table.

Terminals M3 11 – 12: connection for heating pump (P1)

Terminals M3 13 – 14: connection for hot water tank pump (PDHW)

The electrical specifications of the pump must be as follows:

230 V AC; 50 Hz; 1 A max; $\cos \phi > 0.8$.

If the specifications of the installed pump are different, a relay must be wired between the boiler control circuit board and the pump.

It is advisable not to adopt any electrical connection other than those described.

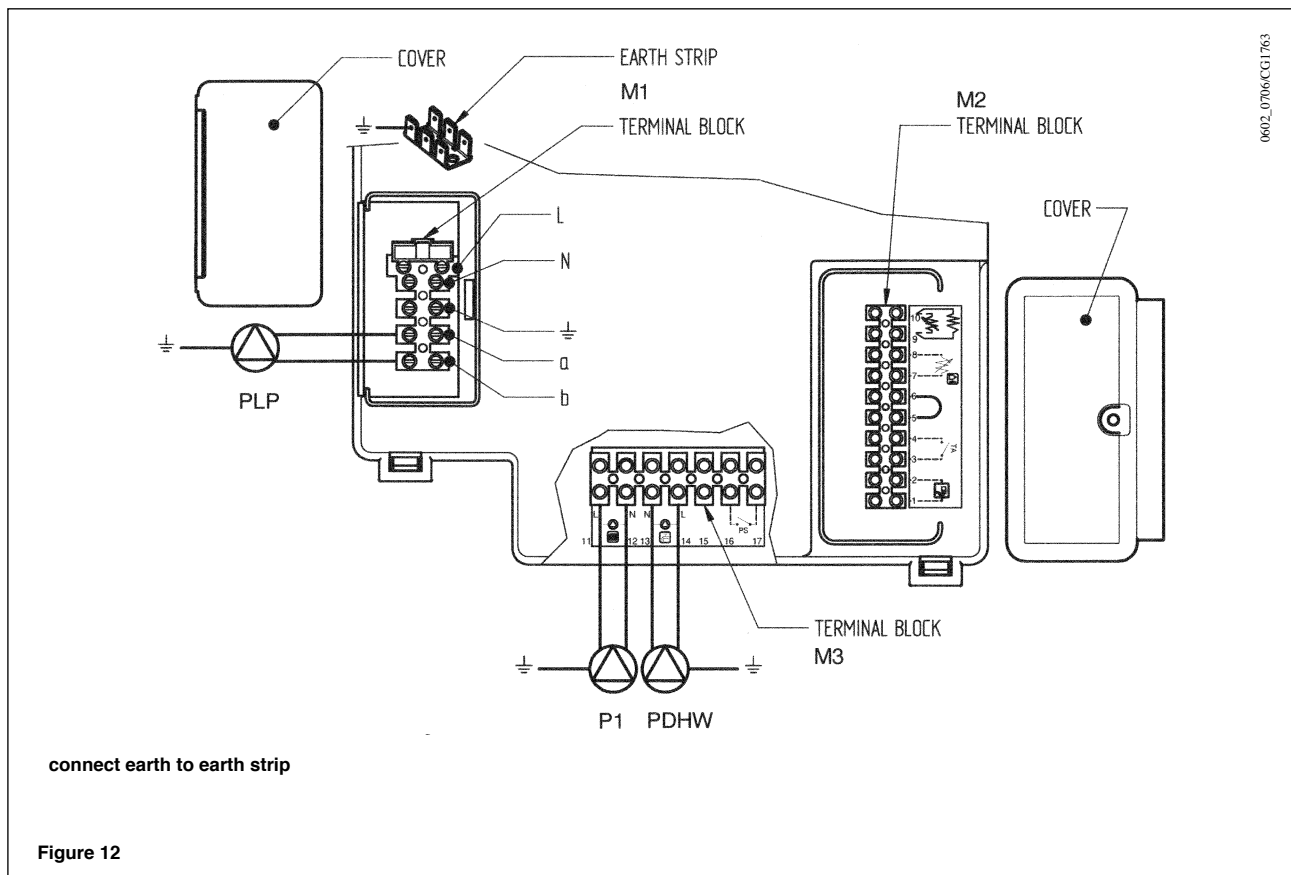

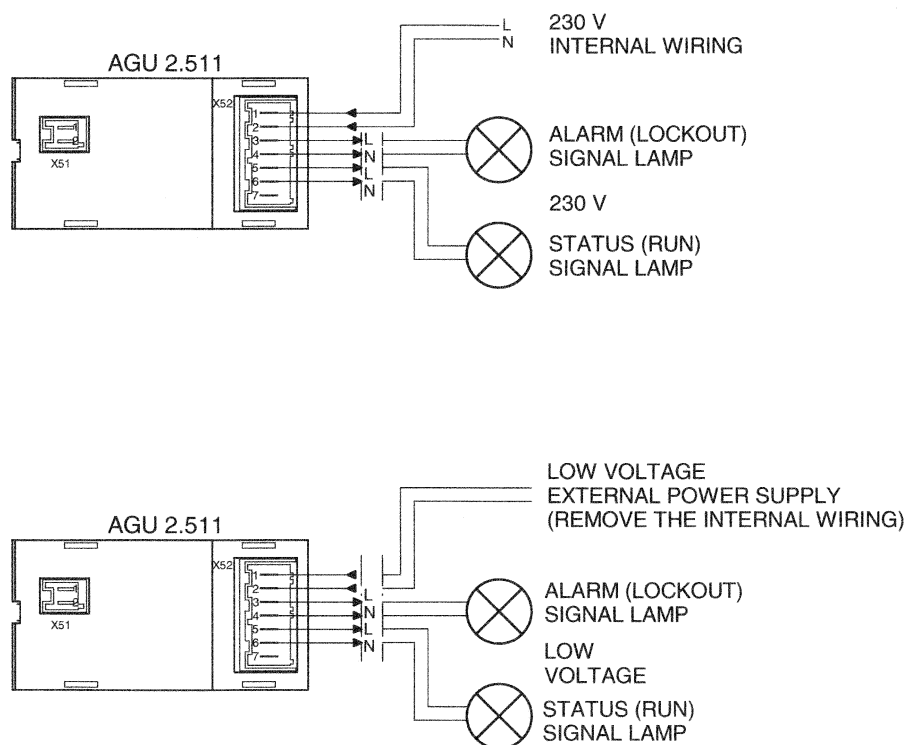

Figure 14

14.3 DESCRIPTION OF THE ELECTRICAL CONNECTIONS TO THE BOILER

Turn the control box downward to access terminal board M2 used for the electrical connections by removing the protective cover (see figure 13).

Terminals 1-2: connection of SIEMENS model QAA73 room temperature regulator supplied as optional extra. Connection polarity is irrelevant.

The link fitted across the “TA” terminals 3-4 must be removed.

Read the instructions supplied with this accessory for correct installation and programming procedures.

Terminals 3-4: “TA” room temperature thermostat connection. Thermostats with integral accelerator resistor must not be used. Check that there is no voltage across the ends of the two thermostat connection wires.

Terminals 5-6: external safety contact (low voltage).

Terminals 7-8: connection of SIEMENS model QAC34 outdoor temperature sensor supplied with the gas boiler.

Read the instructions supplied with this accessory for correct installation procedures.

Terminals 9-10: connection of hot water temperature sensor supplied as optional extra for connecting heating-only boilers to an external water heater.

CLIP-IN AGU 2.511

Terminals 3-4 L-N OUT: connection to signal lamp (230 V - 0,5 A max) for lockout alarm.

Terminals 5-6 L-N OUT: connection to signal lamp (230 V - 0,5 A max) for run mode.

For low voltage signal lamp remove the internal wiring and feed with an external low voltage power supply.

14.4 CONNECTING THE QAA73 TEMPERATURE REGULATOR

The SIEMENS model QAA73 room temperature regulator, if required (optional extra) must be connected to terminals 1-2 of terminal board M2 in figure 13.

The link across terminals 3-4, provided for connection of a room temperature thermostat, must be removed. The settings of the domestic hot water temperature and domestic hot water production schedule must be made using this device.

The timed program of the central heating circuit must be set on the QAA73 if there is a single zone, or in relation to the zone controlled by the QAA73 device.

The timed program for the central heating circuit of the other zones can be set directly on the boiler control panel.

See the instructions provided with the QAA73 room temperature regulator for the user parameter programming procedure.

IMPORTANT: For systems divided into zones, parameter 80 "HC2 curve", which can be set on the QAA73 temperature regulator, must be set as __ . _ "not active".

QAA73: parameters which can be set by the installation engineer (service)

By pressing the two PROG buttons together for at least three seconds it is possible to access the list of parameters that the installer can display and/or set.

Press either of these buttons to change the parameter to display or change.

Press the [+] or [-] key to change the value displayed.



Press either of the PROG buttons again to save the change.

Press the information button (i) to quit programming.

Here follows a list of the most commonly used parameters:

Line no.	Parameter	Range	Default value
70	HC1 curve Selection of central heating circuit temperature curve "kt"	2.5...40	15
72	HC1 max. output Central heating system maximum output temperature	25...85	85
74	Type of building	Light, Heavy	Light
75	Room compensation Activation/deactivation of the influence of the room temperature. If it is deactivated, the outdoor temperature sensor must be installed.	on HC1 on HC2 on HC1+HC2 nil	On HC1
77	Automatic adaptation of the temperature curve "kt" in relation to the room temperature.	On - off	On
78	Opt Start Max Maximum time the boiler is switched on ahead of the timed program to optimise the temperature in the premises.	0...360 min	0
79	Opt Stop Max Maximum time the boiler is switched off ahead of the timed program to optimise the temperature in the premises.	0...360 min	0
80	HC2 curve	2.5...40 —.- = not active	—.-
90	DHW Red Setp Minimum temperature of the domestic hot water	10 or 35...58	10
91	DHW program Selection of the type of timed program for domestic hot water. 24 h/day = always on PROG HC-1h = as HC1 central heating program less one hour PROG HC = as central heating program PROG DHW = specific domestic hot water program (see also program lines 30-36)	24 h/day TSP HC-1h TSP HC TSP DHW	24 h/day

- fault messages

In the event of fault, the display panel on the QAA73 shows the flashing symbol . Press the information key  to display the error code and a description of the fault (see Fault warning tables on paragraph 3.9).

14.5 CONNECTING THE OUTDOOR TEMPERATURE SENSOR



The SIEMENS model QAC34 outdoor temperature sensor for weather compensation must be connected to terminals 7-8 of terminal board M2 in figure 13.

The procedures for setting the gradient of the temperature curve "kt" vary depending on the accessories connected to the boiler.

a) Without QAA73 room temperature regulator:

The temperature curve "kt" must be selected by setting parameter H532 as described in section 16 "setting the boiler parameters".

See graph 2 for selecting the curve referred to a room temperature of 20°C.

The chosen curve can be shifted by pressing the  (2), button (2) on the boiler control panel, and modifying the value displayed by pressing the  and  keys. See graph 3 for curve selection. (The example show in graph 3 refers to the curve Kt=15).

Increase the value displayed if the room temperature required is not reached inside the premises for central heating.

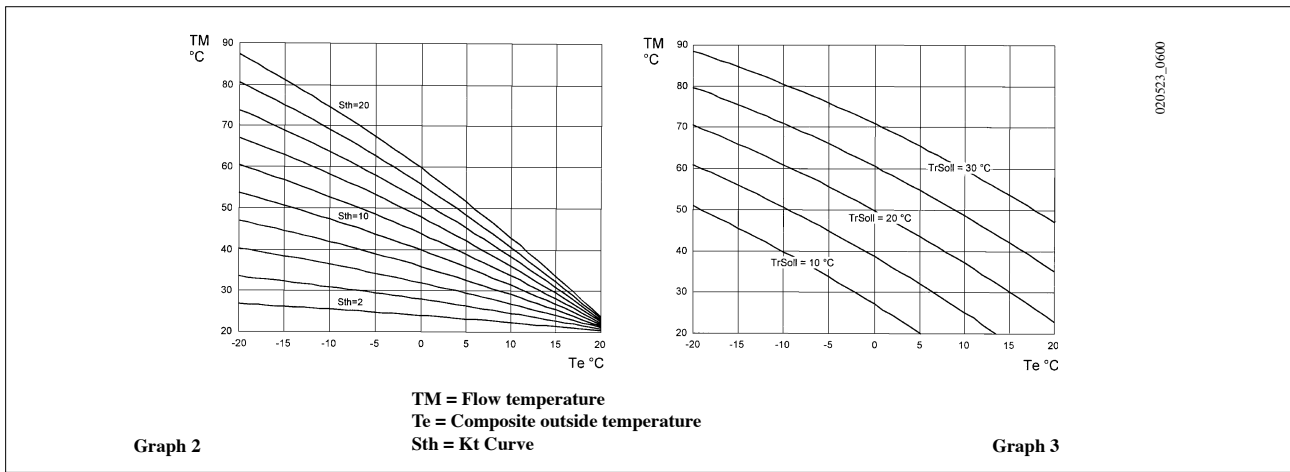

b) With QAA73 room temperature regulator:

The temperature curve “kt” must be selected by setting parameter 70 “HC1 curve” of the QAA73 room temperature control device as described in section 14.4 “QAA73: parameters which can be set by the installation engineer (service)”.

See graph 4 for selecting the curve referred to a room temperature of 20°C.

The curve is shifted automatically on the basis of the room temperature set using the QAA73 climate control.

If the system is divided into zones, the temperature curve “kt” relating to the part of the system not controlled by the QAA73 must be selected by setting parameter H532 as described in section 16 “setting the boiler parameters”.

IMPORTANT: For systems divided into zones, parameter 80 “HC2 curve”, which can be set on the QAA73 room temperature regulator, must be set as _ _ . _ _ “not active” (see section 14.4).

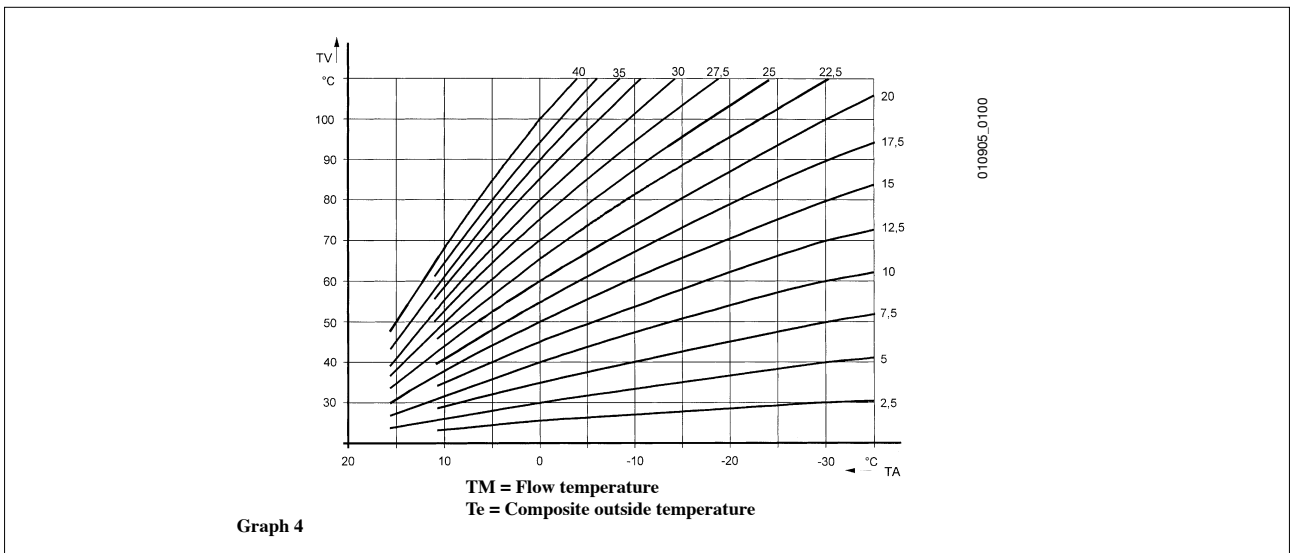

c) With AGU2.500 for control of a low temperature system:

Refer to the instructions provided with the AGU2.500 accessories for connection and control of a low temperature zone.

15. GAS VALVE ADJUSTMENT

Carry out the following operations in the given sequence:

- 1) Calibration of the maximum heat output. Check that the CO₂ measured on the flue, with the boiler operating at the maximum heat output, is the same as that shown in table 1. Otherwise, turn the regulation screw (V) on the gas valve. Turn the screw clockwise to reduce the concentration of CO₂ and anticlockwise to increase it.
- 2) Calibration of reduced heat output. Check that the CO₂ measured on the flue, with the boiler operating at the minimum heat output, is the same as that shown in table 1. Otherwise, turn the offset regulation screw (K) on the gas valve. Turn the screw clockwise to increase the concentration of CO₂ and anticlockwise to reduce it.

- Pi:** Gas supply pressure connection point
- P out:** Gas pressure to burner connection point
- P:** Pressure connection point for measurement of the OFFSET
- PI:** Air signal input from fan
- V:** Gas flow adjuster screw max fire
- K:** OFFSET adjuster screw min fire

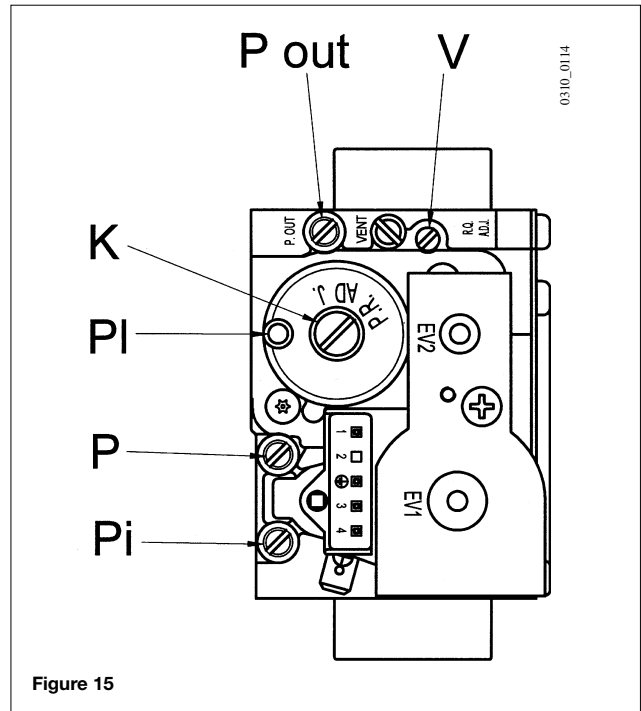

To simplify calibration of the gas valve, the “calibration function” can be set directly on the boiler control panel by proceeding as follows:

- 1) Press the keys (2-3) together until the display shows the pointer “▶” alongside the and symbols (about 6 seconds) (see fig. 16).
- 2) Press the keys to set the fan speed at the minimum and maximum heat output (%PWM);
N.b - to set the **minimum** and **maximum** heat output quickly, press the keys respectively;
- 3) press either of the two keys to exit the function.

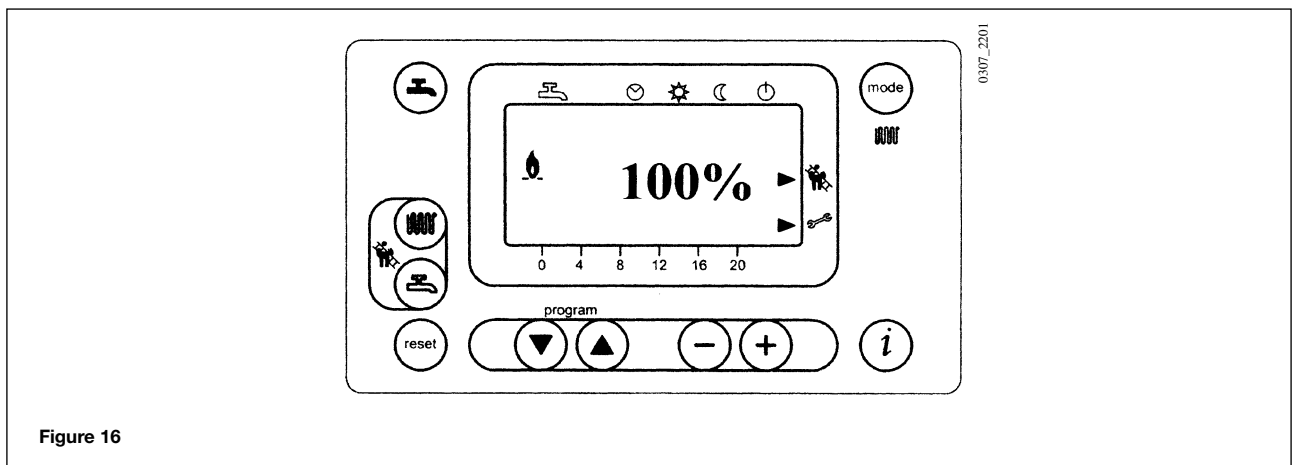

IMPORTANT: in the case of conversion from natural gas to propane (LPG), the following operations must be performed before calibrating the gas valve as illustrated previously:

- Turn adjuster screw (V) on the gas valve through the number of complete revolutions specified in table 3.

	G20 - 2H - 20 mbar	G31 - 3P - 37 mbar
CO ₂ max. heat output	8.7 %	10 %
CO ₂ min. heat output	8.4 %	9.8 %

Table 1

Gas consumption at 15 °C 1013 mbar gas G20 - 2H - 20 mbar	WH 50	WH 60	WH 70
<i>PCI (MJ/m³) NET</i>	34.02	34.02	34.02
Consumption at max. heat output (m ³ /h)	4.91	6.00	7.08
Consumption at min. heat output (m ³ /h)	1.58	1.69	2.11
Gas nozzle (mm)	8.5	15	---

Table 2

Gas consumption at 15 °C 1013 mbar gas G31 - 3P - 37 mbar	WH 50	WH 60	WH 70
<i>PCI (MJ/Kg) NET</i>	46.34	46.34	46.34
Consumption at max. heat output (Kg/h)	3.60	4.40	5.20
Consumption at min. heat output (Kg/h)	1.16	1.24	1.55
Gas nozzle (mm)	8.5	15	---

Table 2.1

Model	Counter clockwise turns of screw (V)
WH 50	3
WH 60	3 ³ / ₄
WH 70	4 ³ / ₄

Table 3

16. SETTING THE BOILER PARAMETERS

The boiler parameters may only be modified by professionally qualified staff proceeding as follows:

- Press the \blacktriangledown \blacktriangle keys on the boiler's front panel together for about 3 s until the parameter H90 appears on the display;
- Press the \blacktriangledown \blacktriangle keys to select the parameter for modification;
- Press the \ominus and \oplus keys to modify the parameter;
- Press the ⓘ key to exit the programming function.

The following are the parameters generally used:

N° parametro	Description	Factory setting
H90	Setting for domestic hot water reduced temperature (°C)	10
H91	D.H.W. (Domestic Hot Water) program (0 = enabled; 1 = disabled)	1
H505	Maximum temperature (°C) of the central heating circuit HC1 corresponding to: <ul style="list-style-type: none"> - the main circuit in systems with just one zone; - the circuit of the zone where the QAA73 temperature control device is installed in case of systems with more than one high-temperature zone; - the high temperature zone circuit in mixed systems and if the SIEMENS AGU2.500 accessory is used. 	80
H507	Maximum temperature (°C) of the central heating circuit HC2 of a system with more than one zone, corresponding to the circuit of the low-temperature zone if the SIEMENS AGU2.500 accessory is used.	80
H516	Automatic Summer / Winter switching temperature (°C).	20
H532	Selection of temperature curve of central heating circuit HC1 (see Graph 1)	15
H533	Selection of temperature curve of central heating circuit HC2 (see Graph 1)	15
H536	Maximum speed at maximum output in heating mode (rpm - maximum speed limitation)	Refer to paragraph 12.1
H612	Setting value of required speed (rpm) at low-fire	
H536-H613	Setting value of required speed (rpm) at high-fire heating / domestic hot water mode	
H541-H610	PWM (%) setting: maximum output in heating / domestic hot water mode	
H544	Pump post-circulation time in central heating mode (min)	10
H545	Burner operating pause time between two start-ups (s)	180
H552	Hydraulic system setting (see instructions provided with the SIEMENS AGU2.500 accessory). H552 = 50 with AGU2.500 H552 = 80 with RVA 47	2
H553	Configuration of heating circuits H553 = 12 with AGU2.500	21
H615	Programmable function	9
H632	Configuration of system with low loss header P1 H632 = 00001111 with AGU2.500 H632 = 00001000 with storage tank without low loss header The value of Bit could be 1 or 0. Press the keys 5 and 6 to select the bit to modify (b0 is the bit on the right, b7 is the last bit on the left). To modify the Bit value press on the keys 7 and 8	00001100
H641	Fan post-purge interval (s)	10
H657	Setpoint of autonomous ANTILEGIONELLA function 60...80 °C = setting temperature range 0 = function inactive	0

Table 4

If the electronic circuit board is replaced, make sure that the parameters set are those specific to the boiler model, as indicated in the documentation available from the authorised Service Centre.

(*) For these parameters see section 13 (hydraulic system).

17. CONTROL AND OPERATION DEVICES

The boiler has been designed in full compliance with European reference standards and in particular is equipped with the following

- **Overheat thermostat**

This thermostat interrupts the gas flow to the main burner in case the water contained in the circuit has overheated. Under these conditions the boiler locks out and can only repeat the ignition procedure by pressing of the reset button on the boiler after the cause of the trip has been rectified.

It is forbidden to disable this safety device

- **Flue thermostat**

This device, positioned on the flue inside the boiler, interrupts the flow of gas to the burner if the temperature exceeds 90 °C. After verifying the cause of the trip, press the reset button positioned on the thermostat itself, then press the reset button on the boiler.

It is forbidden to disable this safety device

- **Flame ionization detector**

The flame sensing electrode guarantees safety of operation in case of gas failure or incomplete interlighting of the main burner.

Under such conditions the boiler is locked out.

You must press the reset button on the boiler to restore the normal operating conditions.

- **Supplementary pump overrun**

After the burner has switched off due to a room thermostat intervention the preset pump overrun of the pump lasts 10 minutes, when the boiler is in the central heating mode.

- **Frost protection device**

The boilers electronic management includes a “frost protection” function in the central heating system which operates the burner to reach a heating flow temperature of 30°C when the system heating flow temperature drops below 5 °C.

This function is enabled as long as the boiler is connected to the a.c. power supply gas supplies and the pressure in the system is as specified.

- **Pump-blocking prevention**

In case there is no call for heat either from the central heating system or from the DHW system for 24 hours on end the pump will automatically switch on for 10 seconds.

- **Gas pressure switch**

This device enables the main burner only to be switched on if the gas pressure is over 12 mbar.

- **Hydraulic pressure sensor**

This device enables the main burner only to be switched on if the system pressure is over 0.5 bar.

18. POSITIONING OF THE IGNITION AND FLAME SENSING ELECTRODE

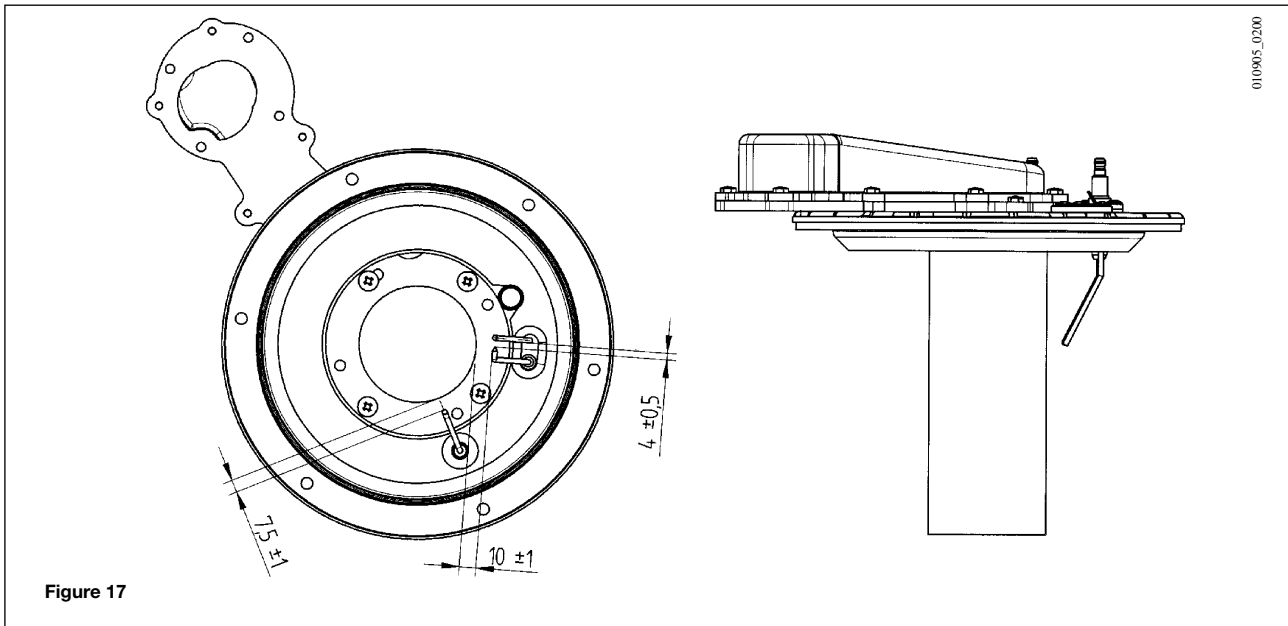

19. CHECK OF COMBUSTION PARAMETERS

To measure the performance of combustion products, the forced draught boiler models are equipped with two test points on the tapered coupling specifically designed for this purpose.

One of the two test points is connected to the exhaust flue duct to allow measurements of the combustion products and efficiency.

The second test point is connected to the comburant air inlet duct to check possible combustion products circulation in case of coaxial ducts.

The exhaust flue duct test point allows measurements of the following:

- combustion products temperature;
- concentration of oxygen (O_2) or, alternatively, of carbon dioxide (CO_2);
- concentration of carbon monoxide (CO).

The comburant air temperature must be measured at the test point connected to the air inlet duct.

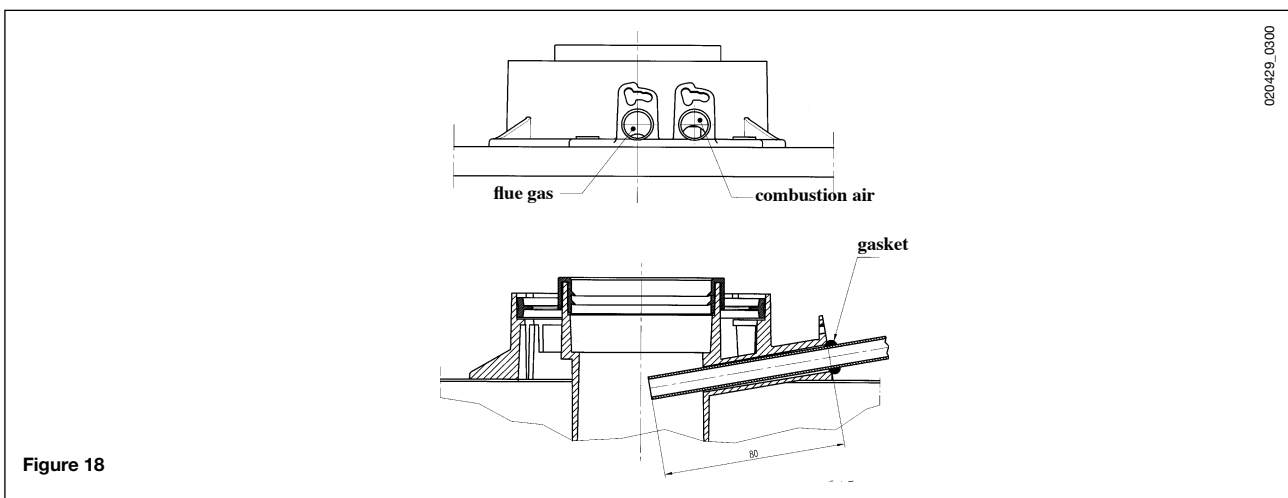

20. ACTIVATING THE CHIMNEY-SWEEP FUNCTION

To facilitate measurement of the combustion efficiency and improve the cleanliness of the production products, the chimney sweep function can be activated by proceeding as described below:

- 1) Press the (2-3) together until the pointer "►" appears on the display alongside the symbol (about 3 seconds but no more than 6 seconds). In these conditions, the boiler operates at the maximum heat output set for central heating.
- 2) Press either of the buttons to exit the function

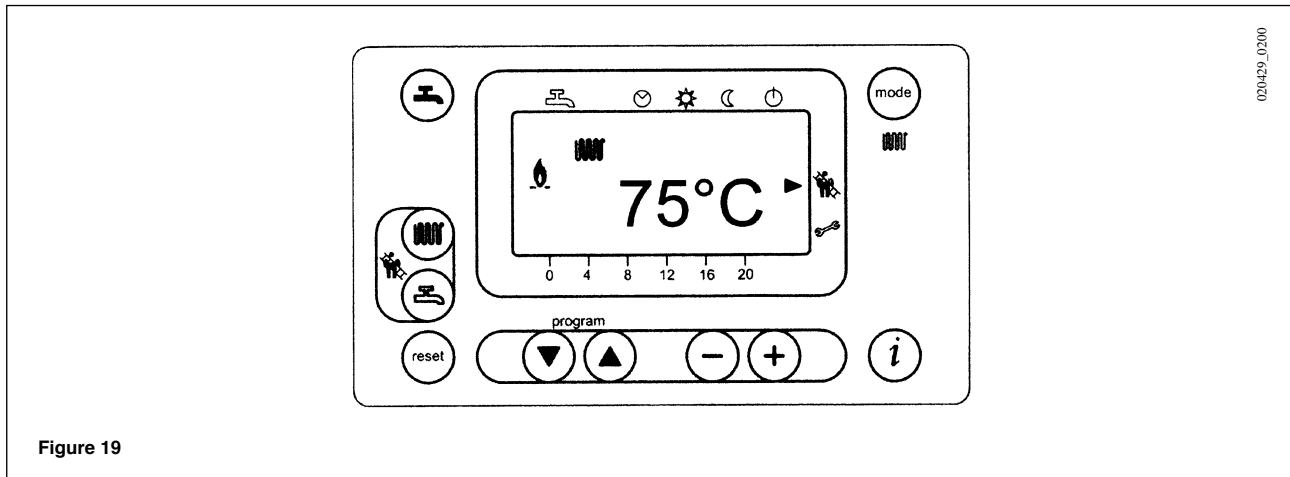

21. ANNUAL SERVICE

To ensure the boiler operates at peak efficiency, the following checks must be performed every year:

- Check on the appearance and tightness of the gas and combustion circuit gaskets;
- Check on the condition and position of the ignition and flame sensing electrodes (see section 18);
- Check on the condition of the burner and its fixing to the aluminium flange;
- Check for any dirt in the combustion chamber. Use a vacuum-cleaner for this cleaning operation,
- Check if the syphon trap is dirty;
- Check that the gas valve is calibrated correctly (see section 15);
- Check on the central heating system pressure.

22. BOILER SCHEMATIC

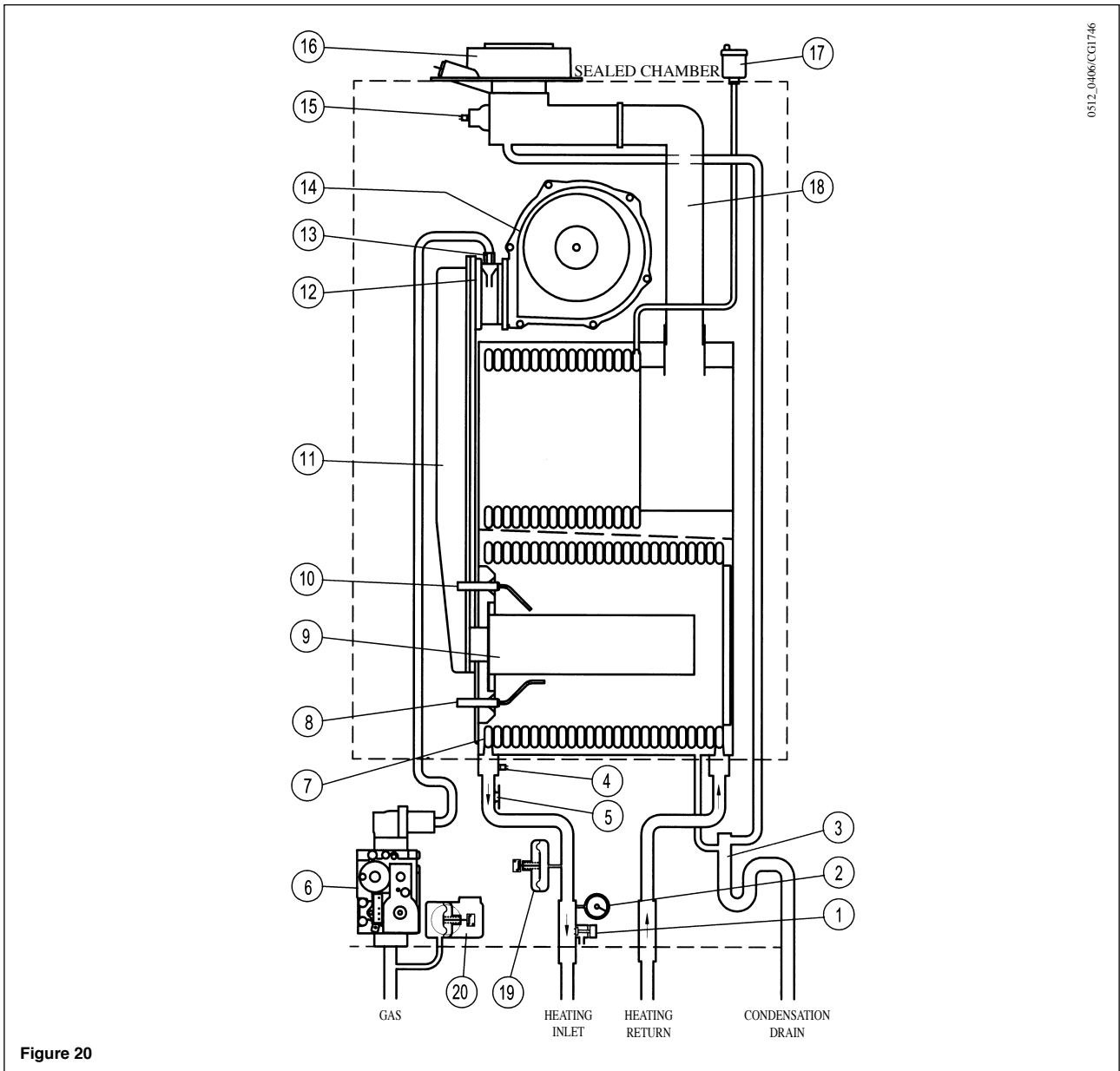
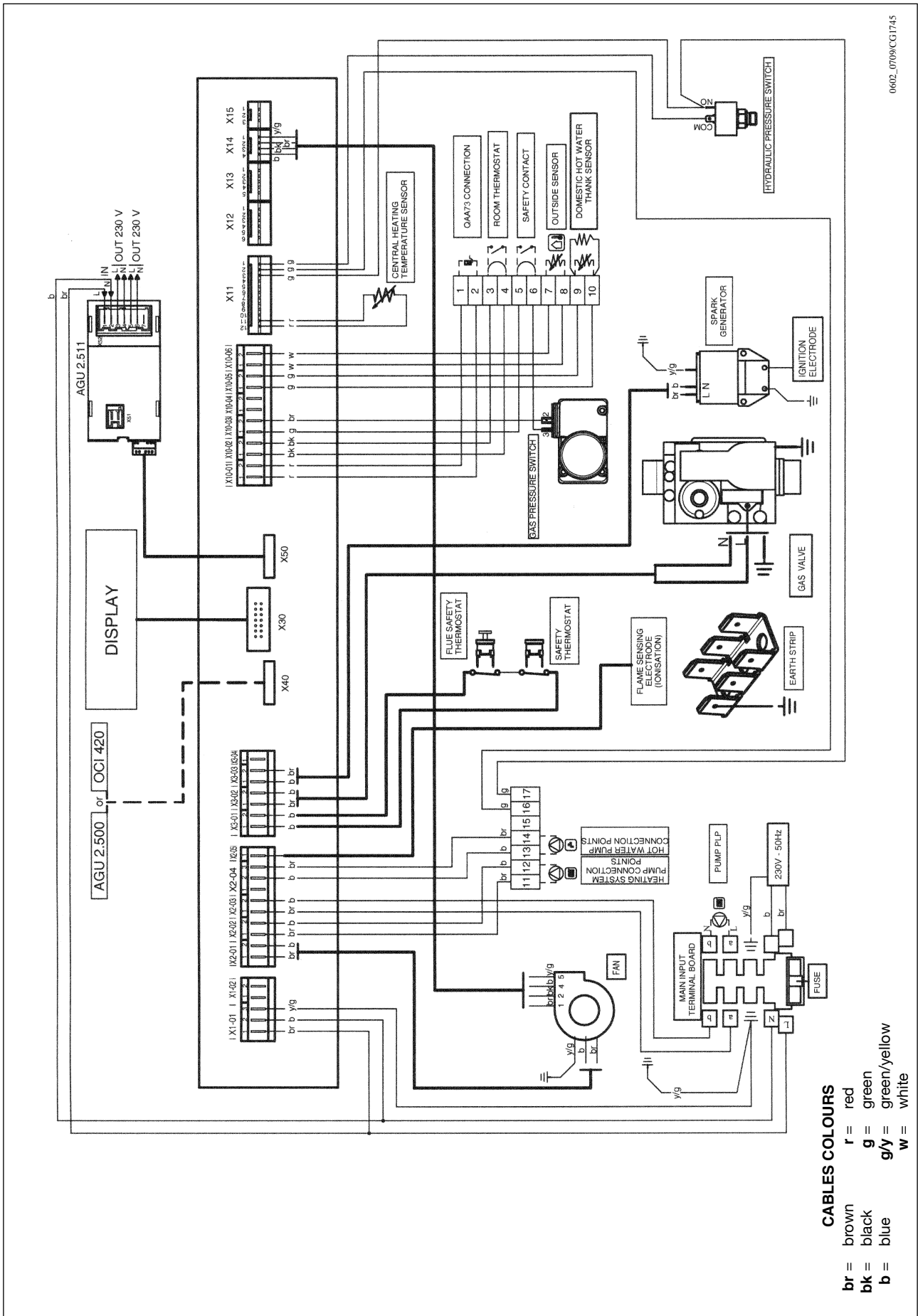

Figure 20

Legend:

- 1 Boiler drain point
- 2 Manometer (water pressure gauge)
- 3 Siphon (condensate)
- 4 Central heating ntc sensor
- 5 105°C overheat thermostat
- 6 Gas valve
- 7 Heat exchanger
- 8 Flame detector electrode (ionisation probe)
- 9 Main burner
- 10 Ignition electrode
- 11 Air/gas mixture header
- 12 Mixer with venturi
- 13 Injector
- 14 Fan
- 15 Flue thermostat
- 16 Flue spigot
- 17 Automatic air vent
- 18 Flue joint
- 19 Hydraulic pressure sensor
- 20 Pressure gas switch

23. ILLUSTRATED WIRING DIAGRAM



0602_0709/CG1745

24. TECHNICAL DATA

Boiler model WH		WH 50	WH 60	WH 70
Category		II _{2H3P}	II _{2H3P}	II _{2H3P}
Nominal heat input (net/gross)	kW	46,4 - 51,5	56,7 - 62,9	67,0 - 74,4
Reduced heat input (net/gross)	kW	15 - 16,6	16,0 - 17,8	20,0 - 22,2
Rated heat output 75/60°C	kW	45,0	55,0	65,0
	kcal/h	38.700	47.300	55.900
Rated heat output 50/30°C	kW	48,7	59,5	70,3
	kcal/h	41.880	51.170	60.460
Reduced heat output 75/60°C	kW	14,5	15,5	19,3
	kcal/h	12.470	13.330	15.820
Reduced heat output 50/30°C	kW	15,8	16,8	21,0
	kcal/h	13.588	14.450	18.060
Useful efficiency according to 92/42/CEE directive	—	★★★★	★★★★	★★★★
Useful efficiency max heat output 75/60 °C net/gross	%	97,3 / 87,3	97,4 / 87,4	97,4 / 87,4
Useful efficiency max heat output 50/30 °C net/gross	%	105,1 / 94,5	105 / 94,5	105,2 / 94,5
Useful efficiency 30% heat output	%	107,6	107,5	107,6
Central heating system max. pressure	bar	4	4	4
Heating circuit temperature range	°C	25÷80	25÷80	25÷80
Type	—	C13 - C33 - C43 - C53 - C63 - C83 - B23		
Concentric flue duct diameter	mm	80	80	80
Concentric air duct diameter	mm	125	125	125
Twin-pipe flue duct diameter	mm	80	80	80
Twin-pipe air duct diameter	mm	80	80	80
Max. flue mass flow rate	kg/s	0,022	0,027	0,032
Min. flue mass flow rate	kg/s	0,007	0,008	0,010
Max. flue temperature	°C	74	78	75
NOx class	—	5	5	5
NOx	mg/kWh	38,4	33,9	37,7
Type of gas used	—	G20	G20	G20
	—	G31	G31	G31
Natural gas pressure 2H	mbar	20	20	20
Propane gas pressure 3P	mbar	37	37	37
Gas Consumption (NG)	m ³ /hr	4,91	6,00	7,08
Gas Consumption (LPG)	m ³ /hr	1,89	2,31	2,74
Minimum Operating Pressure	Bar	1	1	1
High Level Ventilation to BS6644 boiler room	cm ²	92,8	113,4	134
Low Level Ventilation to BS6644 boiler room	cm ²	185,6	226,8	268
Water Flow at 20°C Δt	lit/sec	0,54	0,66	0,78
Hydraulic Resistance at 20°C Δt	kPa	11,7	17,6	20,6
Cold Feed Size to BS6644	mm	19	19	25
Safety valve size to BS6644 (open vent system)	mm	19	19	19
Water Content	lit	5,1	5,6	6,5
Maximum Flow Temperature	°C	85	85	85
Ventilation to BS5440	cm ²			
Power supply voltage	V	230	230	230
Power supply frequency	Hz	50	50	50
Rated power supply	W	75	80	125
Net weight	kg	64	68	72
Dimensions	height	mm	950	950
	width	mm	600	600
	depth	mm	466	466
Protection-limit against humidity and water leakages (**)		IPX5D	IPX5D	IPX5D

(**) according to EN 60529

Commercial sales technical & service enquiries

Tel: 0845 070 1055
Fax: 0845 070 1059
Sales hotline: 0845 070 1056
Technical helpline: 0845 070 1057
Service hotline: 0845 070 1058
e-mail: potterton.commercial@baxigroup.com
web: www.pottertoncommercial.co.uk

Spares

Potterton Commercial spares are available nationwide through the interpart network of approved stockists. Alternatively please contact:-

Interpart

Brooks House
Coventry Road
Warwick CV34 4LL
Tel: 0844 871 1540

Applications & Installations

Our experienced technical support team are available to offer advice on any aspect of heating system design and boiler installation.

Please contact: 0845 070 1057

Commercial service offices

Our service organisation covers the whole of the UK to look after your needs for all Potterton Commercial products.

Our service office offers a wide range of specialised services including:

- Burner commissioning for all fuels
- Boiler service contracts
- Breakdown and repair services
- Burner and boiler replacement
- Oil/gas conversions
- Water treatment and descaling
- Packaged units

All descriptions and illustrations contained within this leaflet have been carefully prepared, but we reserve the right to make changes and improvements in our products which may affect the accuracy of the information in this leaflet.

PART OF BDR THERMEA

Baxi Commercial Division

Wood Lane, Erdington,
Birmingham B24 9QP
Email: potterton.commercial@baxigroup.com
www.pottertoncommercial.co.uk

Sales:

0845 070 1056

Technical:

0845 070 1057

POTTERTON
C O M M E R C I A L

heating specialists